

# DRD2X & OneFrame

## Apex Series Recessed LED Downlight







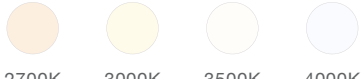

New Construction  
DRDHNJD Deep Junction Box

|               |       |
|---------------|-------|
| Project:      | Type: |
| Product Code: | Date: |

Spec Sheet V-08.15.19



- High-end, architectural-grade illumination with up to 4000 candelas of focused light
- Precise, controlled optics put light exactly where you want it with 20°, 30° and 40° beam angles
- Multiple ratings for compliancy in a wide range of situations
- Unique low profile and small aperture design allows installation in as little as 4" of ceiling space

|  |                                |  |   |
|--|--------------------------------|--|---|
| <b>Application</b><br>New Construction   |                                | <b>Aperture</b><br>4" Octagonal Deep Junction Box  |   |
| <b>Delivered Lumens</b><br>600 lm (10.0W), 750 lm (12.5W)  |                                | <b>Color Quality</b><br>90+ CRI, 2-step SDCM   |   |
| <b>Color Temperature</b><br><br>2700K   3000K   3500K   4000K   |                                | <b>Optics</b><br><br>Spot (20°)   Narrow Flood (30°)   Flood (40°)       |   |
| <b>Surround</b><br>White, Black  |                                | <b>Center Beam Candlepower</b><br>4000cd (Spot 750 lm)   |   |
| <b>Input Voltage</b><br>120/277V   | <b>Dimming</b><br>TRIAC/ELV 5% | <b>Warm Dim Option</b><br> 3000K – 1800K, 600 lm (12.0W), 93+ CRI, 3000cd |   |
| <b>Trims</b><br>Round, Square, Hyperbolic, Pinhole, Beveled Pinhole, Wall Wash, Decorative, Flangeless   |                                | <b>Trim Finish</b><br>White, Black, Silver, Custom   |   |
| <b>Housing Ratings</b><br> Code compliant for use in fire-rated assemblies up to a maximum of 2-hours  STC/IIC Sound Rated  ASTM E283 Certified  Air Tight |                                |  | <b>Module Ratings</b><br> UL Listed for Wet Location |

### Standards



### Guarantee

50,000 hrs | 5 years

### Additional Options

0-10V Dimming, Lutron Hi-lume® Dimming, Emergency Lighting, Concrete Tight, General Lighting, Adjustable Lighting



### PRODUCT BUILDER

#### HOUSING

| PRODUCT CODE         | APPLICATION               | APERTURE                    |
|----------------------|---------------------------|-----------------------------|
| <input type="text"/> | <input type="text"/>      | <input type="text"/>        |
| <b>DRDH</b> Housing  | <b>N</b> New Construction | <b>JD</b> Deep Junction Box |

#### MODULE

| PRODUCT CODE         | LUMENS               | CRI                  | CCT                  | OPTICS                 | SURROUND             |
|----------------------|----------------------|----------------------|----------------------|------------------------|----------------------|
| <input type="text"/> | <input type="text"/> | <input type="text"/> | <input type="text"/> | <input type="text"/>   | <input type="text"/> |
| <b>DRD2X</b> Module  | <b>06</b> 600 lm     | <b>9</b> 90+ CRI     | <b>27</b> 2700K      | <b>SP</b> Spot         | <b>WH</b> White      |
|                      | <b>07</b> 750 lm     |                      | <b>30</b> 3000K      | <b>NF</b> Narrow Flood | <b>BK</b> Black      |
|                      |                      |                      | <b>35</b> 3500K      | <b>FL</b> Flood        |                      |
|                      |                      |                      | <b>40</b> 4000K      |                        |                      |

#### Warm Dim Option

|                     |                  |                  |                         |                        |                 |
|---------------------|------------------|------------------|-------------------------|------------------------|-----------------|
| <b>DRD2X</b> Module | <b>06</b> 600 lm | <b>9</b> 93+ CRI | <b>3W</b> 3000K - 1800K | <b>SP</b> Spot         | <b>WH</b> White |
|                     |                  |                  |                         | <b>NF</b> Narrow Flood | <b>BK</b> Black |
|                     |                  |                  |                         | <b>FL</b> Flood        |                 |

#### TRIM

| PRODUCT CODE         | SHAPE                        | APERTURE                    | STYLE                                   | FINISH                                   | OPTION   |
|----------------------|------------------------------|-----------------------------|---|--|--|
| <input type="text"/> | <input type="text"/>         | <input type="text"/>        | <input type="text"/>                    | <input type="text"/>                     | <input type="text"/>   |
| <b>DRD2T</b> Trim    | <b>R</b> Round               | <b>JD</b> Deep Junction Box | <b>S</b> Standard                       | <b>WH</b> White                          | <b>[Blank]</b> None  |
|                      | <b>S</b> Square <sup>1</sup> |                             | <b>H</b> Hyperbolic <sup>2,3</sup>      | <b>BK</b> Black                          | <b>DOF</b> Decorative: Open, Frosted <sup>2,3,4</sup>                  |
|                      |                              |                             | <b>P</b> Pinhole <sup>2,3</sup>         | <b>SW</b> Silver Reflector, White Flange | <b>DCF</b> Decorative: Closed, Frosted <sup>2,3,4</sup>                |
|                      |                              |                             | <b>B</b> Beveled Pinhole <sup>2,3</sup> | <b>CC</b> Custom Color                   | <b>DCC</b> Decorative: Closed, Clear, Frosted Side <sup>2,3,4</sup>    |
|                      |                              |                             | <b>W</b> Wall Wash <sup>2</sup>         |  | <b>DCCF</b> Decorative: Closed, Clear, Frosted inside <sup>2,3,4</sup> |
|                      |                              |                             |   |  | <b>FL</b> Flangeless <sup>2,3,5</sup>                                  |
|                      |                              |                             |   |  | <b>DF</b> Dead Front <sup>2,3,4</sup>                                  |

**DRDHX-MUD-FL** Flangeless Mud Plate (Required with Flangeless Trim)

<sup>1</sup> Only available in Standard or Wall Wash style

<sup>2</sup> Only available in White or Custom Color finish

<sup>3</sup> Only available in Round shape

<sup>4</sup> Only available in Standard style

<sup>5</sup> Requires DRDHX-MUD-FL Mud Plate



### HOUSING

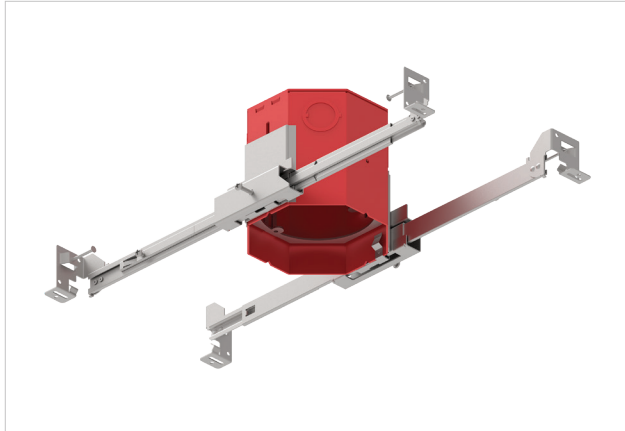

## OneFrame

New Construction Deep Junction Box

**DRDHNJD**

### SUMMARY

**JUNCTION BOX:** Equipped with (8) trade size knockouts (four concentric side ( $\frac{3}{4}'' + \frac{1}{2}''$ ), two concentric top ( $\frac{3}{4}'' + \frac{1}{2}''$ ), two  $\frac{1}{2}''$  top) and (4) Romex knockouts (top) to allow straight conduit runs. Approved for 8 (four in, four out) #12 AWG 70°C.

**MOUNTING:** Pre-installed mounting brackets allow vertical adjustment of bar hangers up to 1".

**CEILING:**  $\frac{1}{2}''$  up to  $1 \frac{3}{4}''$

**CUTOUT:**  $4 \frac{1}{4}''$  (108mm) octagonal opening

**LISTINGS:** Metallic outlet box certified UL514A, code compliant for use in appropriate fire-rated assemblies for up to 2-hours, STC/IIC Sound Rated, ASTM E283 certified Air Tight, IC (Insulation Contact) rated

**WARRANTY:** 5 year limited warranty

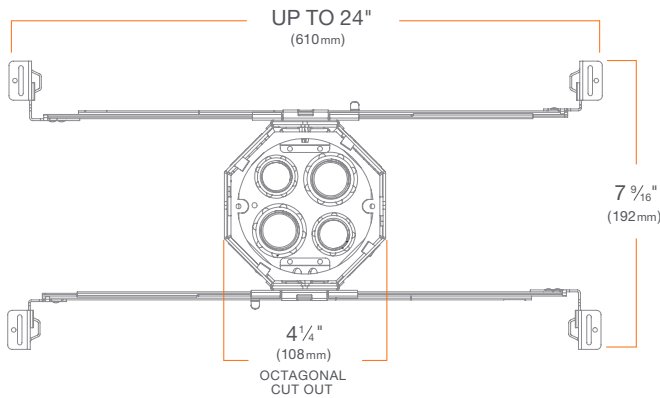
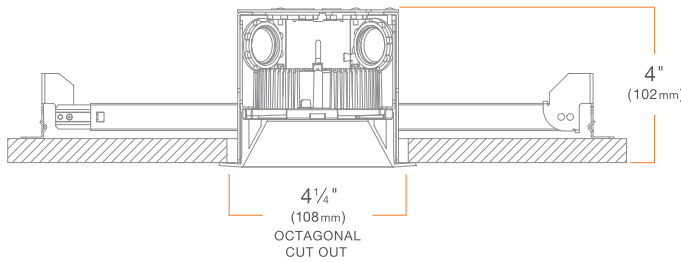

### MODULE

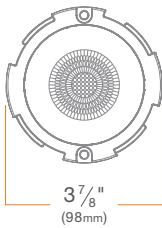
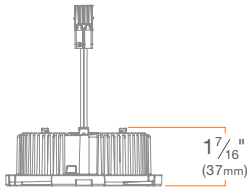

## DRD2X

Apex Series LED Module

### DRD2X

#### SUMMARY

**LED:** Cree® LED

**DELIVERED LUMENS (w Trim):** 600 lm (10.0W), 750 lm (12.5W)

**EFFICACY:** 60 lm/W

**COLOR QUALITY:** 90+ CRI, 2-step SDCM

**CCT:** 2700K, 3000K, 3500K, 4000K

**OPTICS:** Spot (20°), Narrow Flood (30°), Flood (40°)

**SURROUND:** White, Black

**CENTER BEAM CANDLEPOWER:** 4000cd (Spot 750 lm)

**CONNECTOR:** PowerPlug® Luminaire Disconnect Model 182

**DIMMING:** Down to less than 5% for TRIAC/ELV at 120V

**INPUT VOLTAGE:** 120/277V, 50/60Hz

**MAX INPUT CURRENT (120V):** 0.090 amps, 0.107 amps

**MAX INPUT CURRENT (277V):** 0.042 amps, 0.050 amps

**POWER FACTOR:** Greater than 0.9

**TOTAL HARMONIC DISTORTION:** Less than 20%

**AMBIENT OPERATING TEMPERATURE:** -20°C to 40°C

**PHOTOMETRIC TESTING:** Tested in accordance to IESNA LM-79-2008

**LISTINGS:** ENERGY STAR® qualified, California Title 24 2016 JA8 compliant, UL Listed for Wet Location (flanged trims only), cULus Listed

**LIFETIME:** 50,000 hours at 70% lumen maintenance

**WARRANTY:** 5 year limited warranty

#### ● WARM DIM OPTION

**LED:** Bridgelux LED, **DELIVERED LUMENS (w Trim):** 600 lm (12.0W),

**EFFICACY:** 50 lm/W, **COLOR QUALITY:** 93+ CRI, **CCT RANGE:** 3000K

- 1800K, **CENTER BEAM CANDLEPOWER:** 3000cd (Spot), **MAX INPUT**

**CURRENT (120V):** 0.11 amps, **MAX INPUT CURRENT (277V):** 0.047 amps

### TRIM

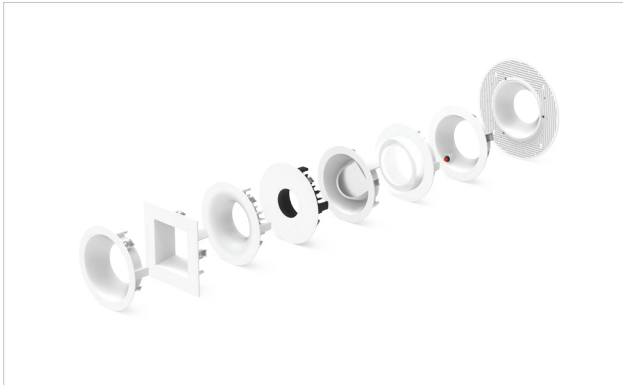

## OneFrame Trims

Recessed LED Downlight Trims

**DRD2T**

### SUMMARY

**CONSTRUCTION:** Die-cast aluminum

**INSTALLATION:** Twist & Lock (flanged trims only)

#### Round Trim

**DRD2TRJDSWH**

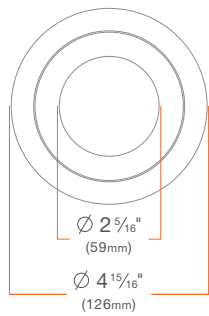
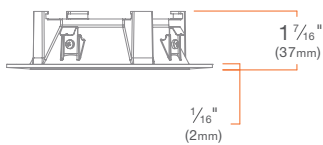

#### Square Trim

**DRD2TSJDSWH**

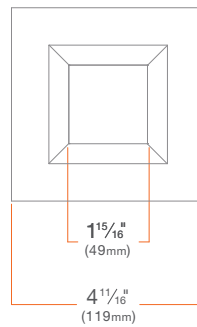
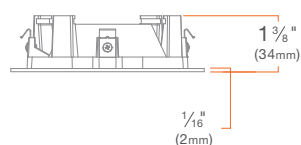

#### Hyperbolic Trim

**DRD2TRJDWH**

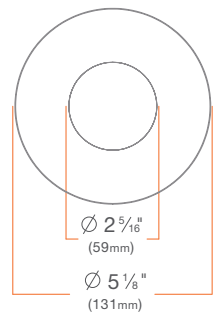
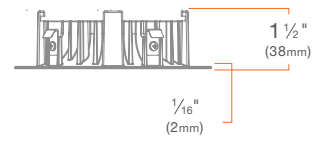

#### Pinhole Trim

**DRD2TRJDPWH**

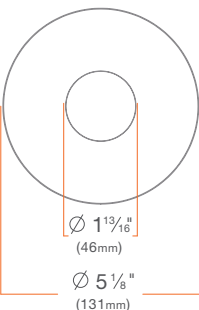
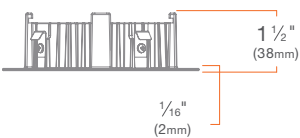

#### Beveled Pinhole Trim

**DRD2TRJDBWH**

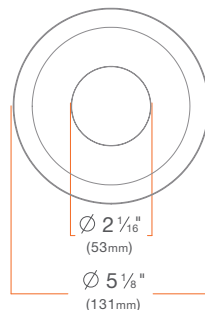
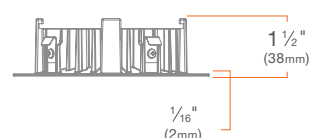

#### Round Wall Wash Trim

**DRD2TRJDWWH**

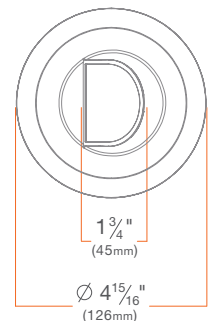
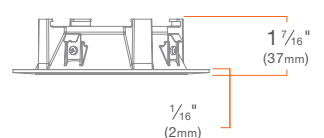

### TRIM

**Square  
Wall Wash Trim**  
DRD2TSJDWWH

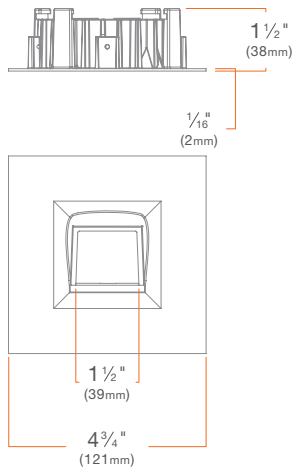

**Round Flangeless  
Trim Insert**  
DRD2TRJDSWHFL

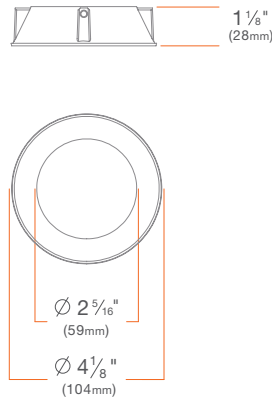

**Hyperbolic Flangeless  
Trim Insert**  
DRD2TRJDHWHFL

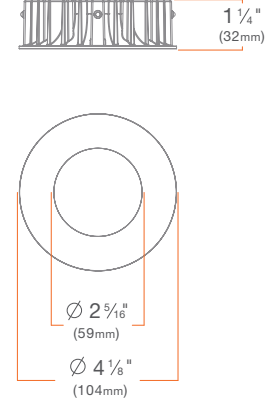

**Pinhole Flangeless  
Trim Insert**  
DRD2TRJDPWHFL

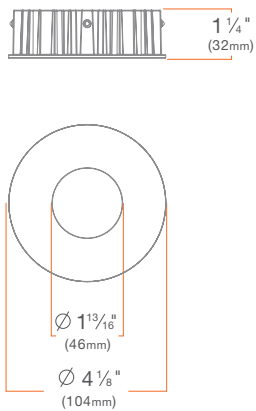

**Beveled Pinhole  
Flangeless Trim Insert**  
DRD2TRJDBWHFL

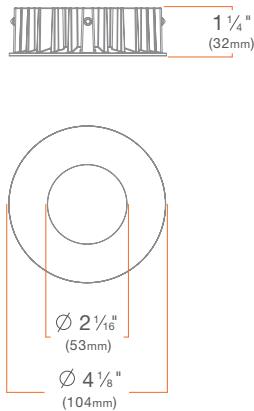

**Wall Wash Flangeless  
Trim Insert**  
DRD2TRJDWWHFL

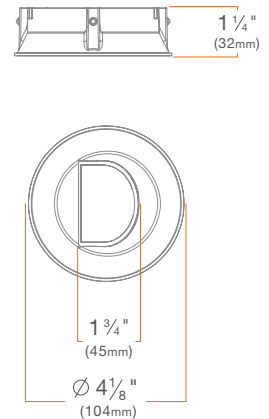

TRIM

**Flangeless  
Mud Plate**

**DRDHX-MUD-FL**

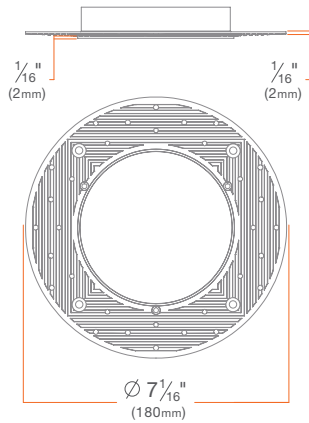

**Decorative Open Trim**

Frosted: **DRD2TRJDSWHDOF**

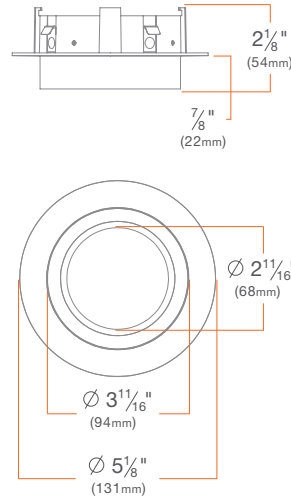

**Decorative Closed Trim**

Frosted: **DRD2TRJDSWHDCF**

Clear, Frosted Inside: **DRD2TRJDSWHGCC**  
Clear, Frosted Sides: **DRD2TRJDSWHGCCF**

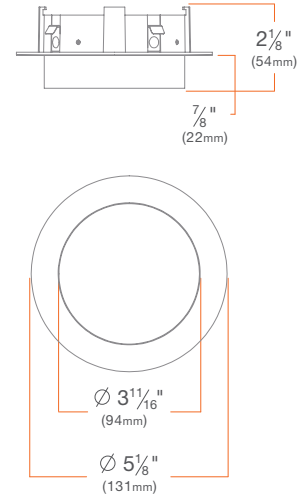

### PHOTOMETRY

#### DRD2X 750 lm, 3000K, Spot, White **DRD2X07930SPWH** / Round Trim White **DRD2TRJDSWH**

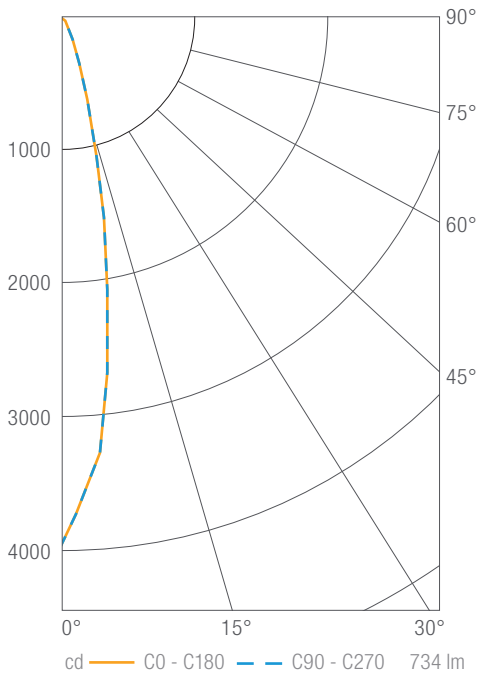

#### Luminous Intensity

| Gamma | C 0° |
|-------|------|
| 0°    | 3949 |
| 5°    | 3303 |
| 10°   | 1934 |
| 15°   | 877  |
| 20°   | 387  |
| 25°   | 183  |
| 30°   | 111  |
| 35°   | 79   |
| 40°   | 56   |
| 45°   | 37   |
| 50°   | 21   |
| 55°   | 11   |
| 60°   | 7    |
| 65°   | 3    |
| 70°   | 3    |
| 75°   | 3    |
| 80°   | 1    |
| 85°   | 1    |
| 90°   | 0    |

Values in candela

#### Zonal Lumen Summary

| Zone  | Lumens | Luminaire % |
|-------|--------|-------------|
| 0-30  | 640    | 87          |
| 0-40  | 689    | 94          |
| 0-60  | 728    | 99          |
| 0-90  | 734    | 100         |
| 0-180 | 734    | 100         |

#### Illuminance Chart

| Distance from LED | Foot Candles | Diameter |
|-------------------|--------------|----------|
| 3'                | 439          | 1.0'     |
| 6'                | 110          | 2.1'     |
| 9'                | 49           | 3.1'     |
| 12'               | 27           | 4.1'     |

Beam Angle: 20°

#### DRD2X 750 lm, 3000K, Narrow Flood, White **DRD2X07930NFWH** / Round Trim White **DRD2TRJDSWH**

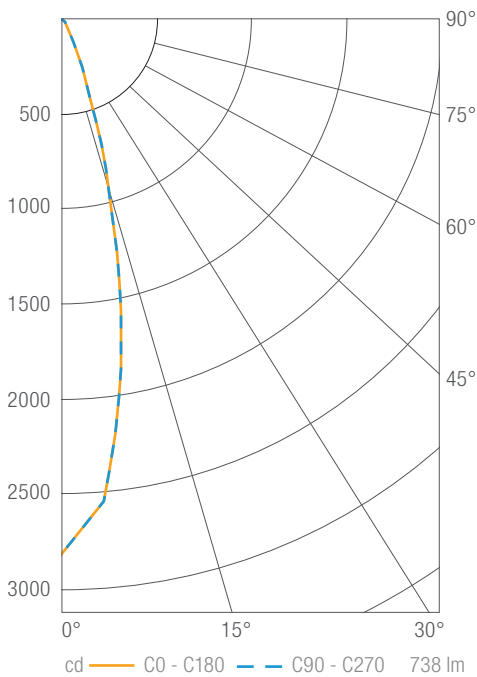

#### Luminous Intensity

| Gamma | C 0° |
|-------|------|
| 0°    | 2827 |
| 5°    | 2575 |
| 10°   | 1845 |
| 15°   | 1032 |
| 20°   | 499  |
| 25°   | 213  |
| 30°   | 119  |
| 35°   | 76   |
| 40°   | 53   |
| 45°   | 38   |
| 50°   | 24   |
| 55°   | 15   |
| 60°   | 7    |
| 65°   | 5    |
| 70°   | 4    |
| 75°   | 3    |
| 80°   | 1    |
| 85°   | 1    |
| 90°   | 0    |

Values in candela

#### Zonal Lumen Summary

| Zone  | Lumens | Luminaire % |
|-------|--------|-------------|
| 0-30  | 636    | 86          |
| 0-40  | 687    | 93          |
| 0-60  | 729    | 99          |
| 0-90  | 738    | 100         |
| 0-180 | 738    | 100         |

#### Illuminance Chart

| Distance from LED | Foot Candles | Diameter |
|-------------------|--------------|----------|
| 3'                | 314          | 1.4'     |
| 6'                | 79           | 2.7'     |
| 9'                | 35           | 4.1'     |
| 12'               | 20           | 5.4'     |

Beam Angle: 26°





**PHOTOMETRY**

**DRD2X 750 lm, 3000K, Flood, White DRD2X07930FLWH / Round Trim White DRD2TRJDSWH**

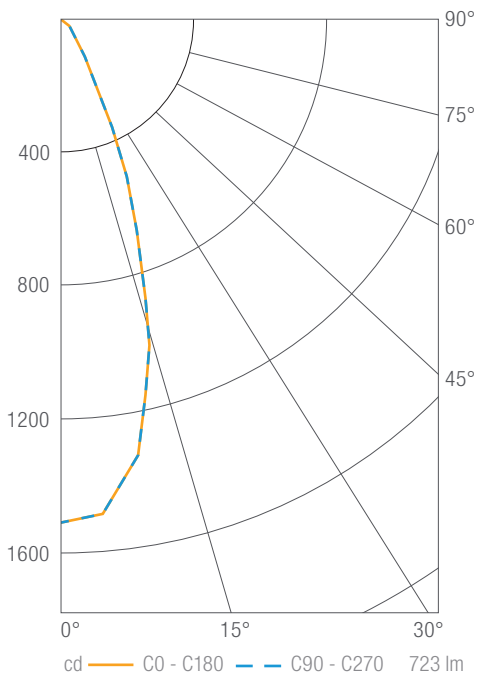

Luminous Intensity

| Gamma | C 0° |
|-------|------|
| 0°    | 1514 |
| 5°    | 1495 |
| 10°   | 1336 |
| 15°   | 1010 |
| 20°   | 634  |
| 25°   | 347  |
| 30°   | 183  |
| 35°   | 102  |
| 40°   | 62   |
| 45°   | 38   |
| 50°   | 21   |
| 55°   | 11   |
| 60°   | 6    |
| 65°   | 5    |
| 70°   | 3    |
| 75°   | 2    |
| 80°   | 2    |
| 85°   | 1    |
| 90°   | 0    |

Values in candela

Zonal Lumen Summary

| Zone  | Lumens | Luminaire % |
|-------|--------|-------------|
| 0-30  | 599    | 83          |
| 0-40  | 673    | 93          |
| 0-60  | 715    | 99          |
| 0-90  | 723    | 100         |
| 0-180 | 723    | 100         |

Illuminance Chart

| Distance from LED | Foot Candles | Diameter |
|-------------------|--------------|----------|
| 3'                | 168          | 2.1'     |
| 6'                | 42           | 4.1'     |
| 9'                | 19           | 6.2'     |
| 12'               | 11           | 8.2'     |

Beam Angle: 38°

**DRD2X Warm Dim 600 lm, 3000K, Spot, White DRD2X0693WSPWH / Round Trim White DRD2TRJDSWH**

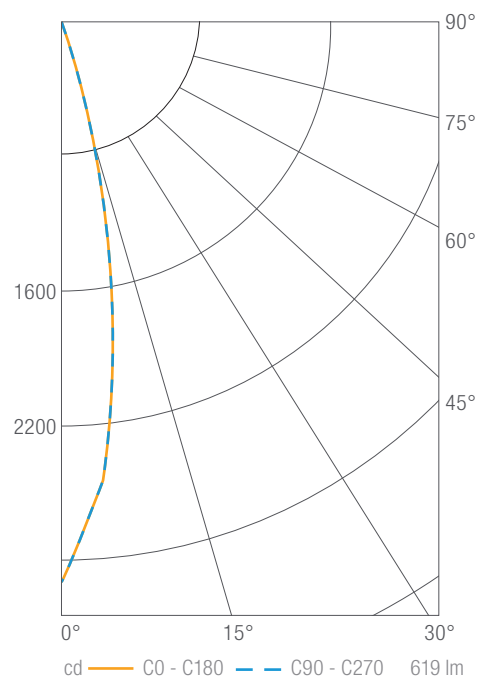

Luminous Intensity

| Gamma | C 0° |
|-------|------|
| 0°    | 3329 |
| 5°    | 2752 |
| 10°   | 1608 |
| 15°   | 733  |
| 20°   | 319  |
| 25°   | 151  |
| 30°   | 91   |
| 35°   | 63   |
| 40°   | 46   |
| 45°   | 30   |
| 50°   | 17   |
| 55°   | 9    |
| 60°   | 5    |
| 65°   | 3    |
| 70°   | 2    |
| 75°   | 2    |
| 80°   | 2    |
| 85°   | 0    |
| 90°   | 0    |

Values in candela

Zonal Lumen Summary

| Zone  | Lumens | Luminaire % |
|-------|--------|-------------|
| 0-30  | 539    | 87          |
| 0-40  | 581    | 94          |
| 0-60  | 613    | 99          |
| 0-90  | 619    | 100         |
| 0-180 | 619    | 100         |

Illuminance Chart

| Distance from LED | Foot Candles | Diameter |
|-------------------|--------------|----------|
| 3'                | 370          | 1.0'     |
| 6'                | 92           | 2.1'     |
| 9'                | 41           | 3.1'     |
| 12'               | 23           | 4.2'     |

Beam Angle: 19°

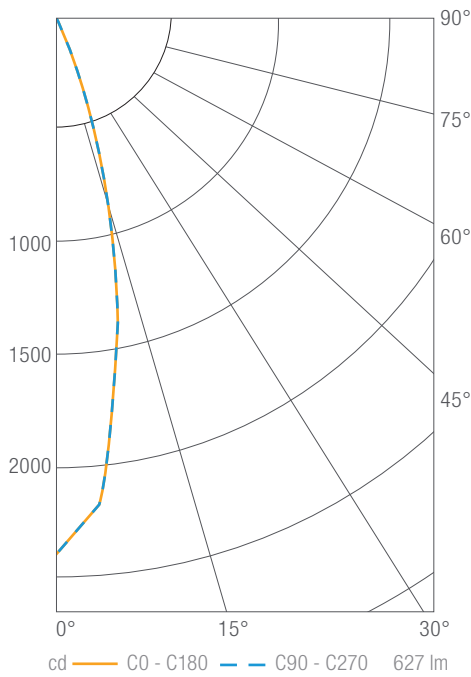
**PHOTOMETRY**
**DRD2X Warm Dim 600 lm, 3000K, N Flood, White DRD2X0693WNFWH / Round Trim White DRD2TRJDSWH**

**Luminous Intensity**

| Gamma | C 0° |
|-------|------|
| 0°    | 2402 |
| 5°    | 2175 |
| 10°   | 1567 |
| 15°   | 892  |
| 20°   | 415  |
| 25°   | 187  |
| 30°   | 103  |
| 35°   | 66   |
| 40°   | 46   |
| 45°   | 32   |
| 50°   | 19   |
| 55°   | 11   |
| 60°   | 7    |
| 65°   | 4    |
| 70°   | 3    |
| 75°   | 2    |
| 80°   | 1    |
| 85°   | 0    |
| 90°   | 0    |

Values in candela

**Zonal Lumen Summary**

| Zone  | Lumens | Luminaire % |
|-------|--------|-------------|
| 0-30  | 541    | 86          |
| 0-40  | 584    | 93          |
| 0-60  | 619    | 99          |
| 0-90  | 627    | 100         |
| 0-180 | 627    | 100         |

**Illuminance Chart**

| Distance from LED | Foot Candles | Diameter |
|-------------------|--------------|----------|
| 3'                | 267          | 1.3      |
| 6'                | 67           | 2.7      |
| 9'                | 30           | 4.0      |
| 12'               | 17           | 5.4      |

Beam Angle: 26°

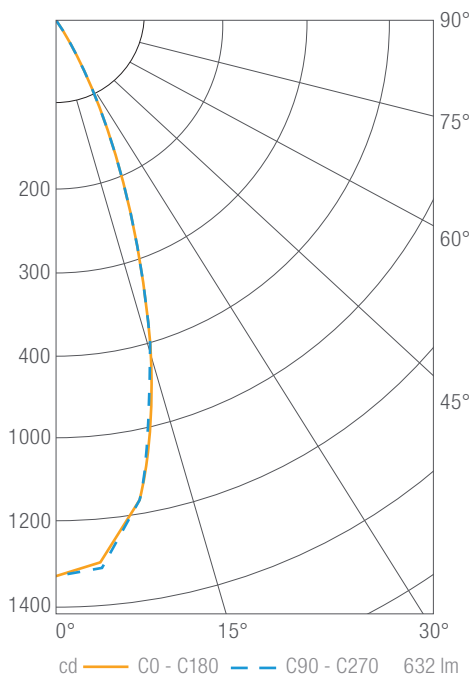
**DRD2X Warm Dim 600 lm, 3000K, Flood, White DRD2X0693WFLWH / Round Trim White DRD2TRJDSWH**

**Luminous Intensity**

| Gamma | C 0° |
|-------|------|
| 0°    | 1324 |
| 5°    | 1293 |
| 10°   | 1166 |
| 15°   | 909  |
| 20°   | 595  |
| 25°   | 335  |
| 30°   | 179  |
| 35°   | 97   |
| 40°   | 58   |
| 45°   | 35   |
| 50°   | 19   |
| 55°   | 8    |
| 60°   | 5    |
| 65°   | 3    |
| 70°   | 2    |
| 75°   | 1    |
| 80°   | 1    |
| 85°   | 1    |
| 90°   | 0    |

Values in candela

**Zonal Lumen Summary**

| Zone  | Lumens | Luminaire % |
|-------|--------|-------------|
| 0-30  | 524    | 83          |
| 0-40  | 588    | 93          |
| 0-60  | 625    | 99          |
| 0-90  | 632    | 100         |
| 0-180 | 632    | 100         |

**Illuminance Chart**

| Distance from LED | Foot Candles | Diameter |
|-------------------|--------------|----------|
| 3'                | 147          | 2.0'     |
| 6'                | 37           | 4.0'     |
| 9'                | 16           | 6.0'     |
| 12'               | 9            | 8.0'     |

Beam Angle: 39°

**Lumen Scaling**

| DRD2X06 (600 lm) | DRD2X07 (750 lm) |
|------------------|------------------|
| 0.80             | 1.00             |

**CCT Scaling**

| DRD2X07927 (2700K) | DRD2X07930 (3000K) | DRD2X07935 (3500K) | DRD2X07940 (4000K) |
|--------------------|--------------------|--------------------|--------------------|
| 0.93               | 1.00               | 1.00               | 1.07               |

**DIMMER COMPATIBILITY****Recommended Phase-control Dimmers** (Dims down to 5% nominal measured light output)

| Brand            | Series                 | Model Number  | Max Load DRD2X06 | Max Load DRD2X07 |
|------------------|------------------------|---|------------------|------------------|
| <b>Control 4</b> | Control 4              | C4-APD120   | 10               | 9                |
| <b>Cooper</b>    | Decorator              | DLC03P, DAL06P  | 25               | 20               |
| <b>Legrand</b>   | Adorne                 | ADTP703TU   | 35               | 30               |
| <b>Lutron</b>    | Caseta                 | PD-6WCL   | 12               | 10               |
|                  | CL Series              | AYCL-153, CTCL-153, DVCL-153, LGCL-513, SCL-153, TGCL-513 | 12               | 10               |
|                  | CL Series              | AYCL-253, DVCL-253  | 20               | 15               |
|                  | Grafik Eye 3000        | QSGR-3P   | 30               | 25               |
|                  | Grafik Sys / Homeworks | RPM-4A  | 25               | 20               |
|                  | Grafik Sys / Homeworks | RPM-4U  | 30               | 25               |
|                  | Maestro CL             | MACL-153M, MSCL-OP153M, MSCL-VP153M                       | 12               | 10               |
|                  | Maestro Wireless       | MRF2-6ELV, MRF2-6CL                                       | 12               | 10               |
|                  | Radio RA               | RRD-6NA, RRD-6CL, RRD-6D                                  | 12               | 10               |

**Compatible Phase-control Dimmers<sup>1</sup>** (Dims down to 20% nominal measured light output)

| Brand               | Series                   | Model Number          | Max Load DRD2X06 | Max Load DRD2X07 |
|---------------------|--------------------------|-----------------------|------------------|------------------|
| <b>Cooper</b>       | Slide                    | SLC03P, SAL06P        | 25               | 20               |
| <b>Legrand</b>      | Harmony                  | H703PTU, HCL453P      | 30               | 25               |
| <b>Leviton</b>      | IllumaTech Slide         | IPE04                 | 25               | 20               |
|                     | SureSlide                | 6621, 6674            | 10               | 10               |
| <b>Lutron</b>       | Diva                     | DV-600                | 12               | 10               |
|                     | Maestro                  | MA-600                | 12               | 9                |
|                     | Maestro ELV              | MAELV-600, MSCELV-600 | 35               | 30               |
|                     | Maestro Wireless         | MRF2-6ND              | 12               | 10               |
|                     | Power Booster            | PHPM-PA, PHPM-WBX     | 25               | 20               |
| <b>Philips</b>      | Sunrise                  | SR400RPC120, ZP260QEW | 20               | 15               |
| <b>Watt Stopper</b> | Digital Light Management | LMRC-221              | 160              | 150              |
|                     | Dimming Sensor           | PW-100D               | 14               | 12               |

<sup>1</sup> Dimmer compatibility reflects performance compatibility only. Please reference your local codes for application.

**DIMMER COMPATIBILITY****Recommended Phase-control Dimmers - Warm Dim** (Dims down to 5% nominal measured light output)

| Brand          | Series     | Model Number                        | Max Load |
|----------------|------------|-------------------------------------|----------|
| <b>Cooper</b>  | Decorator  | DAL06P, DLC03P                      | 20       |
|                | Slide      | SLC03P                              | 20       |
| <b>Leviton</b> | Sure Slide | 6621, 6631                          | 10       |
| <b>Lutron</b>  | Diva CL    | DVCL-153P                           | 10       |
|                | Diva CL    | DVCL-253P                           | 15       |
|                | Grafik     | GTJ-150-WH                          | 10       |
|                | Maestro    | MRF2-6ND                            | 10       |
|                | Maestro CL | MACL-153                            | 10       |
|                | Maestro CL | MA-PRO-WH                           | 15       |
|                | Maestro CL | MACL-153M, MSCL-OP153M, MSCL-VP153M | 10       |
|                | Radio RA   | RRD-6NA, RRD-6ND                    | 10       |
| Skylark        | SELV-300P  | 20                                  |          |

# OneFrame System Options

Complete Downlighting Solution

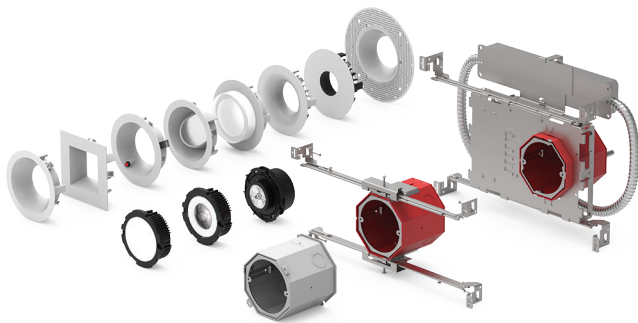

## General Recessed LED Downlight

### **DRD2 & OneFrame**

DRDHNJD Deep Junction Box

### **DRD2 & OneFrame Alt/EM**

Alternate Dimming and/or Emergency Lighting  
DRDHNJD Deep Junction Box

### **DRD2 & OneFrame Concrete**

Concrete Tight  
DRDHNJC Deep Junction Box

## Apex Series Recessed LED Downlight

### **DRD2X & OneFrame**

DRDHNJD Deep Junction Box

### **DRD2X & OneFrame Alt/EM**

Alternate Dimming and/or Emergency Lighting  
DRDHNJD Deep Junction Box

### **DRD2X & OneFrame Concrete**

Concrete Tight  
DRDHNJC Deep Junction Box

## Adjustable Recessed LED Downlight

### **DRD4 & OneFrame**

DRDHNJD Deep Junction Box

### **DRD4 & OneFrame Alt/EM**

Alternate Dimming and/or Emergency Lighting  
DRDHNJD Deep Junction Box

### **DRD4 & OneFrame Concrete**

Concrete Tight  
DRDHNJC Deep Junction Box