

DCC2

LED Cylinder

Surface, Cord, Stem, Wall Mount

Project:	Type:
Product Code:	Date:

Spec Sheet V-12.01.19



Large, white, surface mount shown

- The DCC2 cylinder's combination of precise illumination and refined aesthetics can take your designs to new heights
- Available in a range of form factors, mounting options, and color finishes, the DCC2 can be configured exactly the way you want it
- Constructed from die-cast aluminum with no visible hardware for a sleek, completely symmetrical design

Lumen Output 750 lm (10.8W), 1000 lm (12.8W), 1500 lm (19.5W), 2000 lm (29.0W)	Mount Surface, Stem, Cord, Wall, Wall Up/Down	
Color Quality 90+ CRI, 2-step SDCM	Size Length: Small (4"), Medium (8"), Large (12") Diameter: 4"	
Color Temperature 2700K 3000K 3500K 4000K	Finish White, Black, Brushed Aluminum, Bronze, Custom	Stem/Cord Length 24" (standard), Up to 96" (custom)
Light Distribution General	Input Voltage 120/277V	Dimming TRIAC/ELV 5% 0-10V 1% Lutron Hi-lume® 1%

Emergency Lighting

Optional Remote Inverter or Emergency LED Driver for lighting up to 90 minutes in event of power failure

Standards 	Ratings Wet location available	Guarantee 50,000 hrs 5 years
----------------------	--	--

PRODUCT BUILDER
CYLINDER

PRODUCT CODE	MOUNT & CYLINDER		SIZE	LUMENS		CCT		FINISH		DRIVER			
<input type="text"/>	<input type="text"/>		<input type="text"/>	<input type="text"/>		<input type="text"/>		<input type="text"/>		<input type="text"/>			
DCC2	Cylinder	SW	Surface Mount, Wet	S	Small	07	750 lm	27	2700K	WH	White	[Blank]	TRIAC/ELV
		CM	Cord Mount ^{1,2}	M	Medium	10	1000 lm	30	3000K	BK	Black	O	0-10V ³
		TM	Stem Mount ¹	L	Large	15	1500 lm ⁴	35	3500K	BZ	Bronze	C	Lutron LDE1 ^{3,6}
		TW	Stem Mount, Wet ¹			20	2000 lm ⁴	40	4000K	BA	Brushed Aluminum	L	Lutron LTEA2W ^{3,7}
		WM	Wall Mount ³			77	750 lm up/down ⁵			CC	Custom Color	TE	TRIAC/ELV, Remote Inverter
		WW	Wall Mount, Wet ³			11	1000 lm up/down ⁵					OE	0-10V, EM Driver ³
						71	750/1000 lm up/down ⁵					CE	Lutron LDE1, EM Driver ^{3,6}
												LE	Lutron LTEA2W, EM Driver ^{3,7}

ACCESSORIES

<input type="text"/>	
DCC2X-CCM	Custom Length Cord Mount (up to 96") ¹
DCC2X-CTM	Custom Length Stem Mount (up to 96") ¹
DCC2X-48CM	48" Alternate Length Cord Mount ¹
DCC2X-DFT	Decorative Frosted Trim

¹ 24" standard length, 48" no charge alternate length (cord); Use Custom Order Form to specify custom length

² White cord standard for White finish, black cord standard for Black or Bronze finish, silver cord standard for Brushed Aluminum finish; unless specified otherwise

³ Only available in Medium or Large size

⁴ Only available in Large size, 0-10V or Lutron driver

⁵ Only applicable for Large Wall Mounts

⁶ Lutron LDE1 Dimming refers to Lutron Hi-lume 1% EcoSystem LED driver with Soft-on, Fade-to-Black

⁷ Lutron LTEA2W Dimming refers to Lutron Hi-lume 1% 2-wire LED driver, 120V only

PRODUCT SUMMARY



Large, black, stem mount shown

SUMMARY

LED: Cree® LED

DELIVERED LUMENS: 750 lm (10.8W), 1000 lm (12.8W), 1500 lm (19.5W), 2000 lm (29.0W)

EFFICACY: 80 lm/W, 85 lm/W, 77 lm/W, 69 lm/W

COLOR QUALITY: 90+ CRI, 2-step SDCM

CCT: 2700K, 3000K, 3500K, 4000K

DIMMING: Down to less than 5% for TRIAC/ELV at 120V, 1% for 0-10V or Lutron Hi-lume® 1% at 120/277V

INPUT VOLTAGE: 120/277V, 50/60Hz

MAX INPUT CURRENT (120V): 0.10 amps, 0.13 amps, 0.26 amps, 0.37 amps

MAX INPUT CURRENT (277V): 0.04 amps, 0.05 amps, 0.12 amps, 0.16 amps

POWER FACTOR: Greater than 0.9

TOTAL HARMONIC DISTORTION: Less than 20%

AMBIENT OPERATING TEMPERATURE: -20°C to 40°C

EMERGENCY LIGHTING: Optional installer mounted Remote Inverter or Emergency LED Driver for lighting up to 90 minutes in event of power failure

PHOTOMETRIC TESTING: Tested in accordance to IESNA LM-79-2008

LISTINGS: ENERGY STAR® qualified, California Title 24 2016 JA8 compliant, UL Listed for Wet Location (option), cULus Listed

LIFETIME: 50,000 hours at 70% lumen maintenance

CYLINDER: Extruded aluminum; 4" (small), 8" (medium), 12" (large)

FINISH: White, Black, Bronze, Brushed Aluminum, Custom Color

PENDANT: 24" standard, 48" no charge alternate (cord), custom length available up to 96". Cord: White, black or silver with round canopy. Stem: Painted steel stem with round canopy and hanging straight endpoint with up to 30° tilt (meets CA IR 16-9).

MOUNT: Surface, Cord, Stem: Installs in most 3" octagonal, 4" octagonal, 3" round and 4" round boxes. Wall Mount: Installs in most one-gang switch boxes. Wet Location Wall Mount: Installs in most two-gang switch, 3" octagonal, 4" octagonal, 3" round, 4" round and 4" square boxes.

WARRANTY: 5 year limited warranty

CYLINDER DIMENSIONS

**Surface Mount,
Wet Location LED Cylinder**
DCC2SW

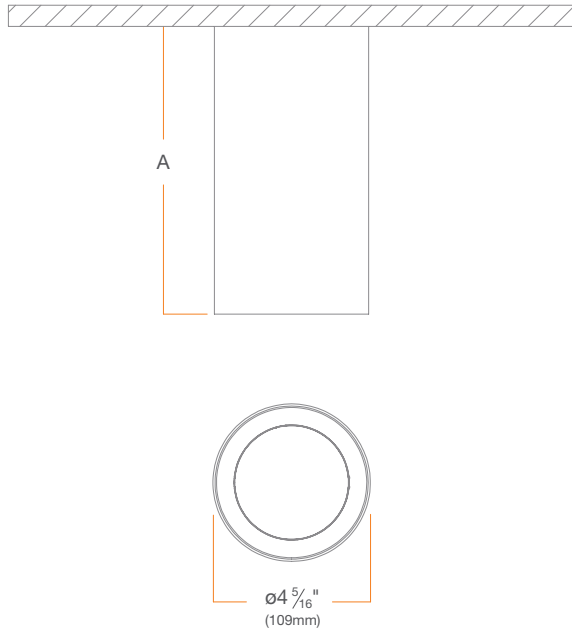

**Surface Mount, Wet Location LED Cylinder
with Decorative Frosted Trim**
DCC2SW + DCC2X-DFT

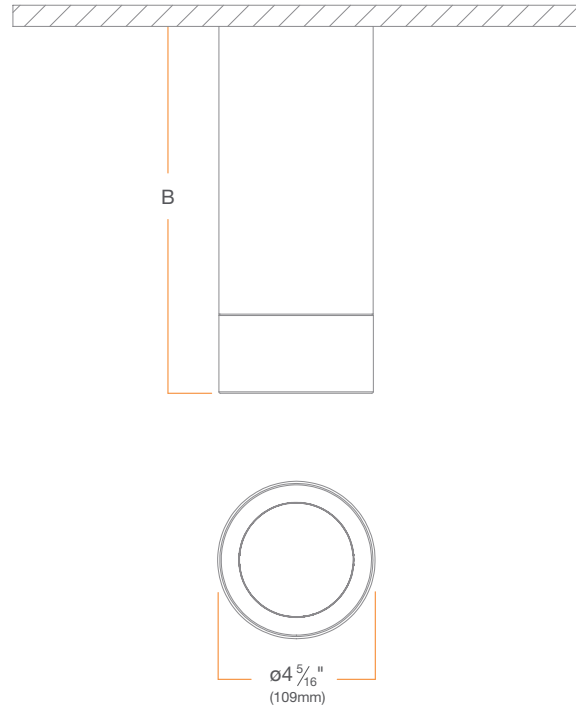

CYLINDER SIZE	A
Small	4" [102 mm]
Medium	8" [203 mm]
Large	12" [305 mm]

CYLINDER SIZE	B
Small	6 3/16" [158 mm]
Medium	10 3/16" [259 mm]
Large	14 3/16" [361 mm]

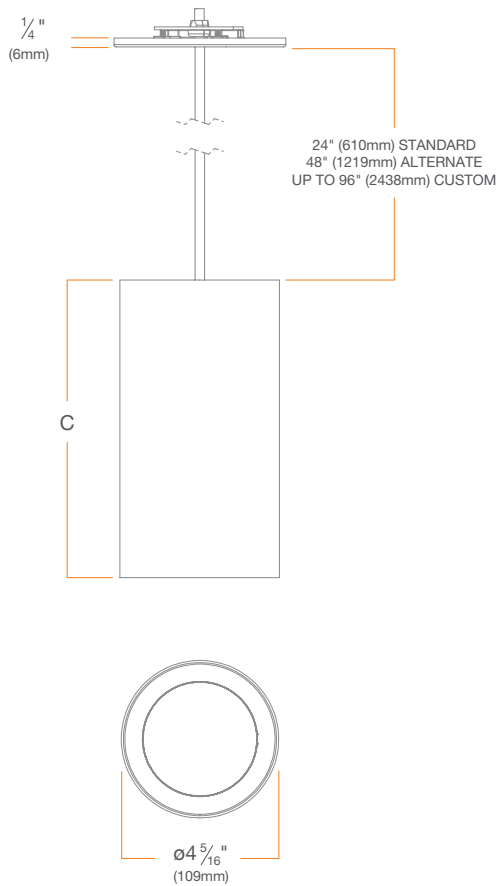
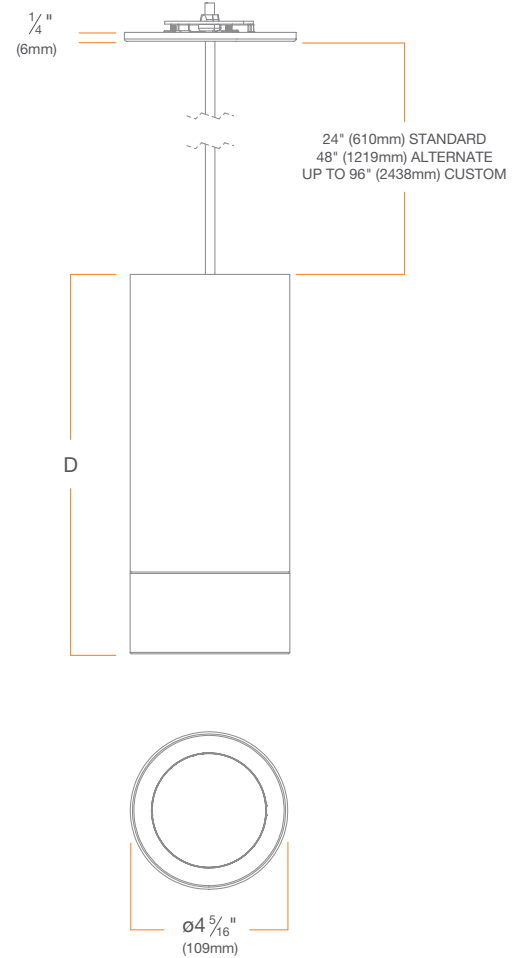
CYLINDER DIMENSIONS
**Cord Mount
LED Cylinder**
DCC2CM

**Cord Mount LED Cylinder
with Decorative Frosted Trim**
DCC2CM + DCC2X-DFT

CYLINDER SIZE	C
Small	4" [102 mm]
Medium	8" [203 mm]
Large	12" [305 mm]

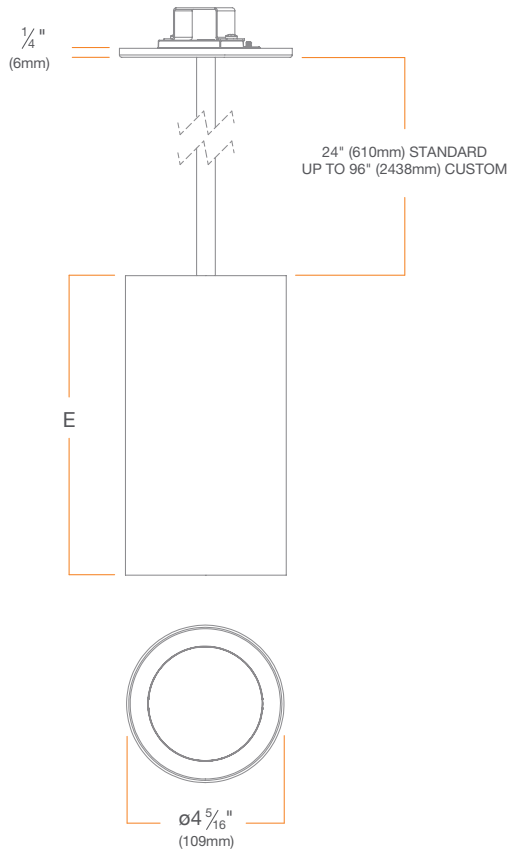
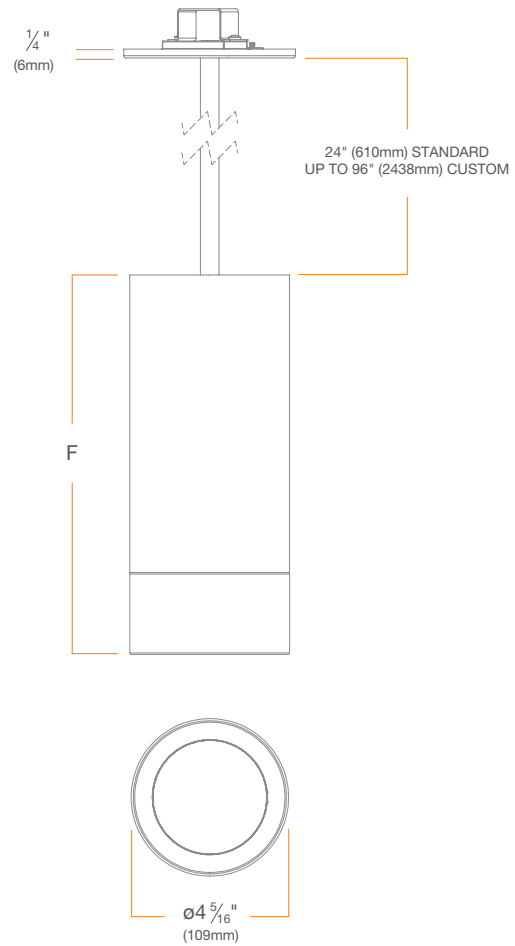
CYLINDER SIZE	D
Small	6 3/16" [158 mm]
Medium	10 3/16" [259 mm]
Large	14 3/16" [361 mm]

CYLINDER DIMENSIONS
**Stem Mount
LED Cylinder**
DCC2TM

**Stem Mount LED Cylinder
with Decorative Frosted Trim**
DCC2TM + DCC2X-DFT

CYLINDER SIZE	E
Small	4" [102 mm]
Medium	8" [203 mm]
Large	12" [305 mm]

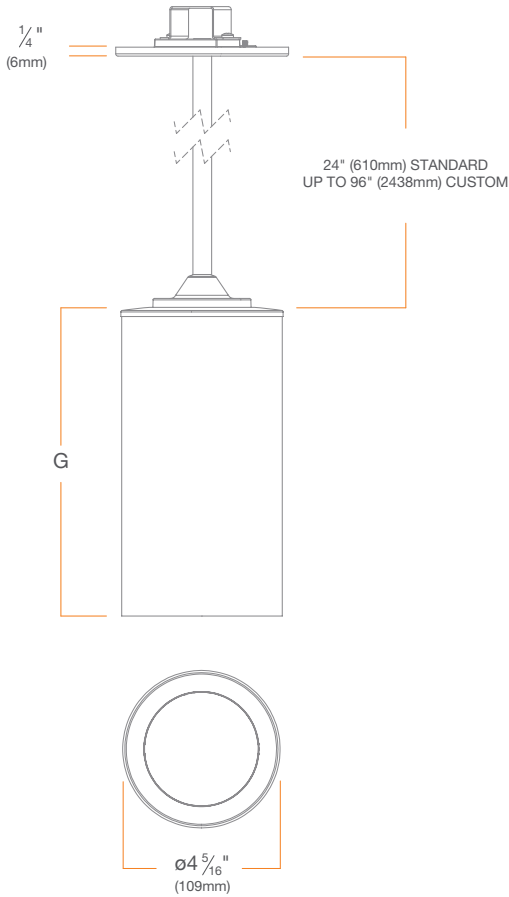
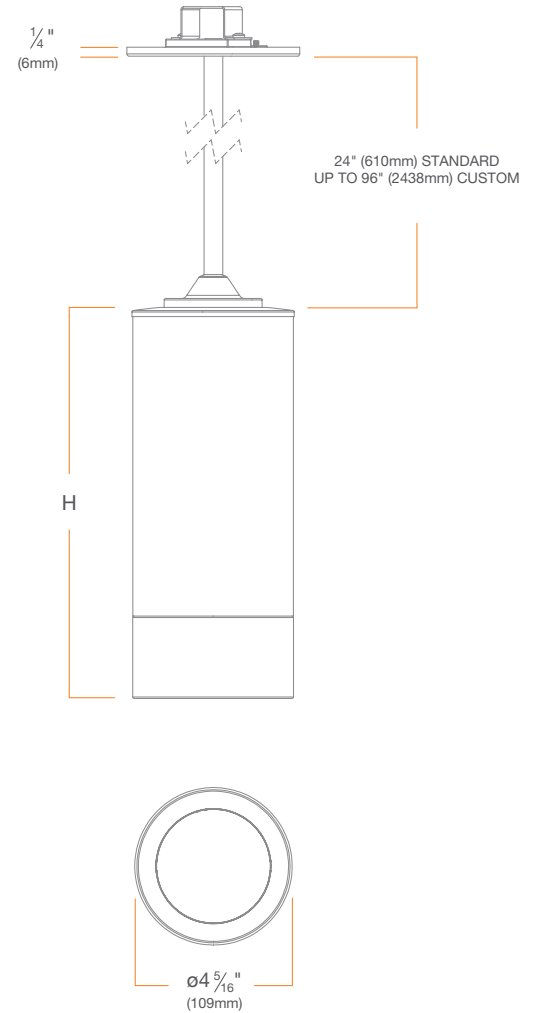
CYLINDER SIZE	F
Small	6 3/16" [158 mm]
Medium	10 3/16" [259 mm]
Large	14 3/16" [361 mm]

CYLINDER DIMENSIONS
**Stem Mount, Wet Location
LED Cylinder**
DCC2TW

**Stem Mount, Wet Location LED Cylinder
with Decorative Frosted Trim**
DCC2TW + DCC2X-DFT

CYLINDER SIZE	G
Small	4 $\frac{1}{4}$ " [108 mm]
Medium	8 $\frac{1}{4}$ " [210 mm]
Large	12 $\frac{1}{4}$ " [311 mm]

CYLINDER SIZE	H
Small	6 $\frac{7}{16}$ " [164 mm]
Medium	10 $\frac{7}{16}$ " [265 mm]
Large	14 $\frac{7}{16}$ " [367 mm]

CYLINDER DIMENSIONS

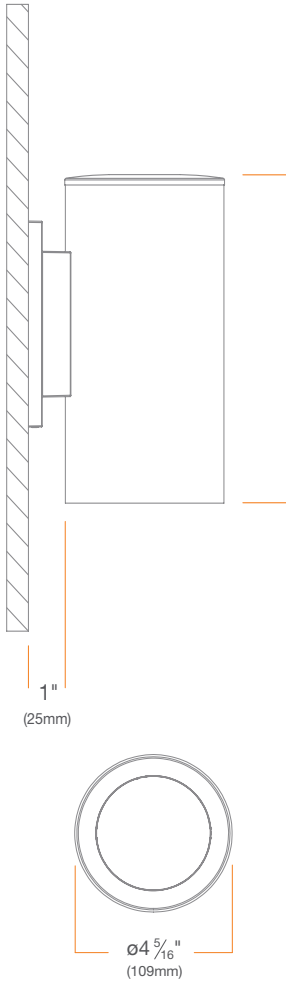
**Wall Mount Downlight
LED Cylinder**
DCC2WM



**Wall Mount Downlight LED Cylinder
with Decorative Frosted Trim**
DCC2WM + DCC2X-DFT

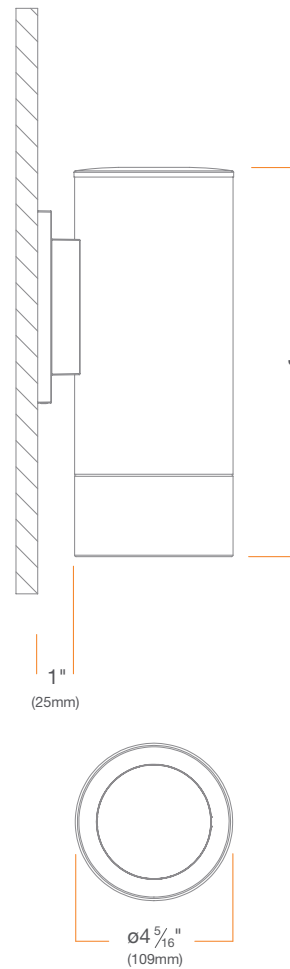

CYLINDER SIZE	I
Medium	8 1/4" [210 mm]
Large	12 1/4" [311 mm]

CYLINDER SIZE	J
Medium	10 7/16" [266 mm]
Large	14 7/16" [367 mm]

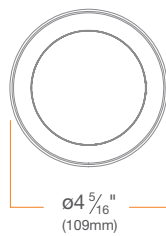
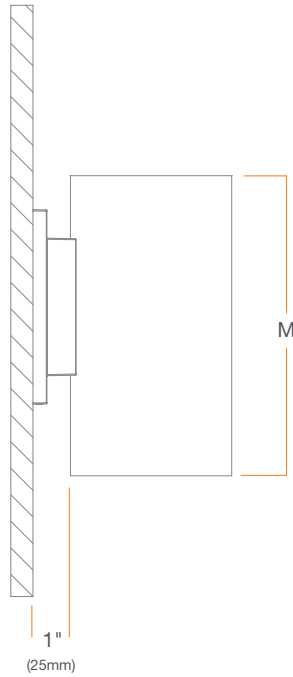
CYLINDER DIMENSIONS
Wall Mount Up and Downlight LED Cylinder
DCC2WM

CYLINDER SIZE	M
Large	12" [305 mm]

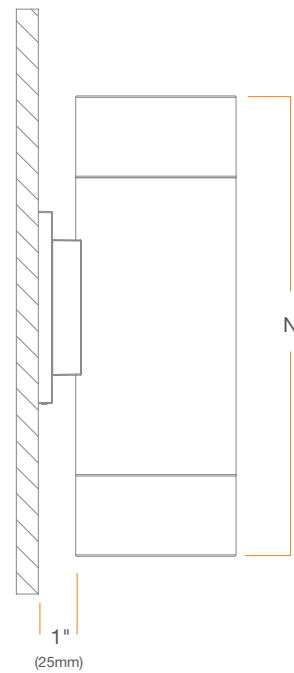
Wall Mount Up and Downlight LED Cylinder with Decorative Frosted Trim
DCC2WM + DCC2X-DFT

CYLINDER SIZE	N
Large	16 3/8" [416 mm]

CYLINDER DIMENSIONS

Wall Mount, Wet Location Downlight LED Cylinder

DCC2WW

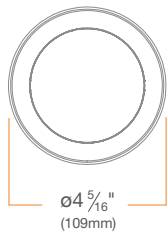
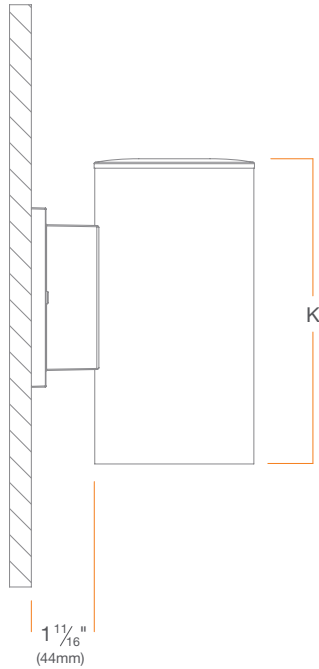

Wall Mount, Wet Location Downlight LED Cylinder with Decorative Frosted Trim

DCC2WW + DCC2X-DFT

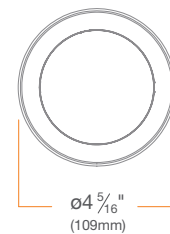
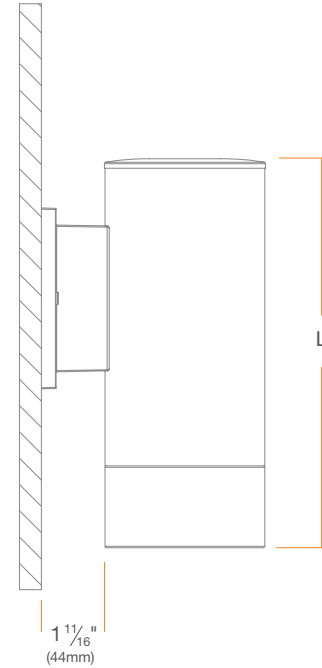

CYLINDER SIZE	K
Medium	8 1/4" [210 mm]
Large	12 1/4" [311 mm]

CYLINDER SIZE	L
Medium	10 7/16" [266 mm]
Large	14 7/16" [367 mm]

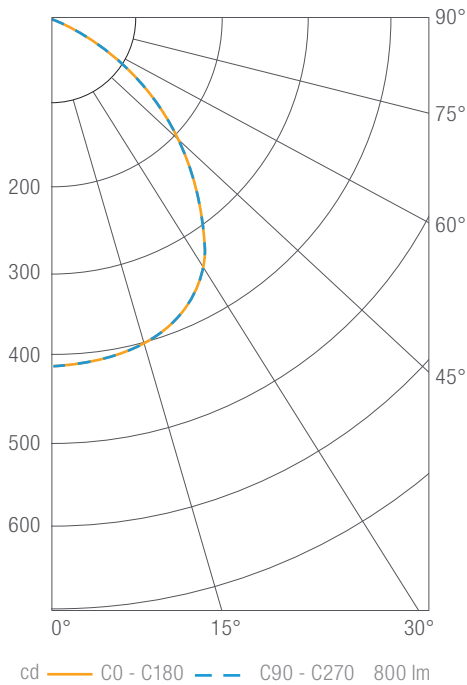
PHOTOMETRY
DCC2 Cord Mount, Medium, 750 lm, 93 CRI, 3000K, White DCC2CMM0730WH

Luminous Intensity

Gamma	C 0°
0°	413
5°	411
10°	407
15°	401
20°	392
25°	378
30°	354
35°	315
40°	261
45°	195
50°	131
55°	86
60°	57
65°	37
70°	20
75°	10
80°	5
85°	2
90°	0

Values in candela
Zonal Lumen Summary

Zone	Lumens	Luminaire %
0-30	326	41
0-40	521	65
0-60	750	94
0-90	800	100
0-180	800	100

Illuminance Chart

Distance from LED	Foot Candles	Diameter
2.5'	66	4.9'
5.0'	17	9.7'
7.5'	7	14.5'
9.0'	5	17.4'

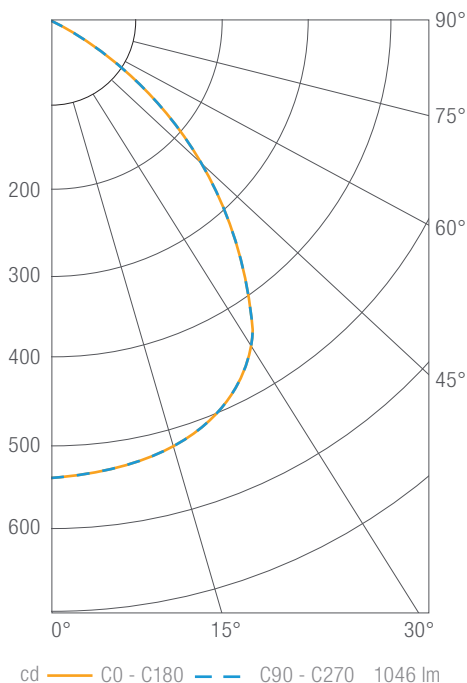
Beam Angle: 88°
DCC2 Cord Mount, Medium, 1000 lm, 93 CRI, 3000K, White DCC2CMM1030WH

Luminous Intensity

Gamma	C 0°
0°	540
5°	537
10°	532
15°	523
20°	510
25°	492
30°	461
35°	411
40°	342
45°	256
50°	172
55°	113
60°	74
65°	48
70°	27
75°	13
80°	6
85°	2
90°	0

Values in candela
Zonal Lumen Summary

Zone	Lumens	Luminaire %
0-30	425	41
0-40	679	65
0-60	980	94
0-90	1046	100
0-180	1046	100

Illuminance Chart

Distance from LED	Foot Candles	Diameter
2.5'	86	4.9'
5.0'	22	9.7'
7.5'	10	14.6'
9.0'	7	17.5'

Beam Angle: 88°

PHOTOMETRY

DCC2 Cord Mount, Medium, 1500 lm, 90 CRI, 3000K, White **DCC2CMM1530WH**

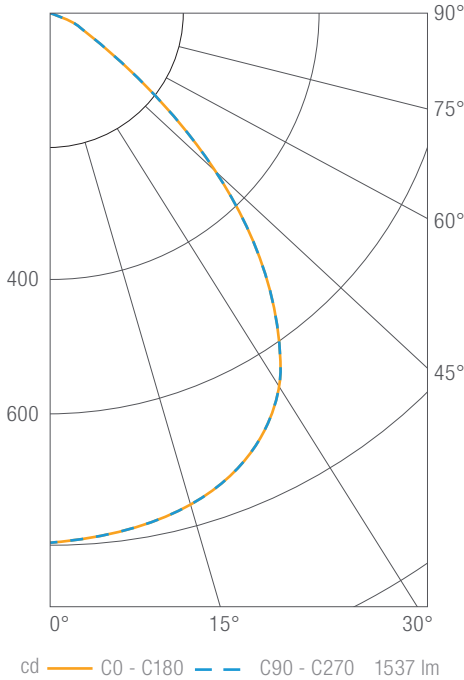

Luminous Intensity

Gamma	C 0°
0°	794
5°	790
10°	781
15°	768
20°	750
25°	723
30°	678
35°	605
40°	502
45°	376
50°	254
55°	166
60°	109
65°	70
70°	39
75°	19
80°	9
85°	3
90°	0

Values in candela

Zonal Lumen Summary

Zone	Lumens	Luminaire %
0-30	624	41
0-40	999	65
0-60	1441	94
0-90	1537	100
0-180	1537	100

Illuminance Chart

Distance from LED	Foot Candles	Diameter
2.5'	127	4.9'
5.0'	32	9.7'
7.5'	14	14.6'
9.0'	10	17.5'

Beam Angle: 88°

DCC2 Cord Mount, Medium, 2000 lm, 90 CRI, 3000K, White **DCC2CMM2030WH**

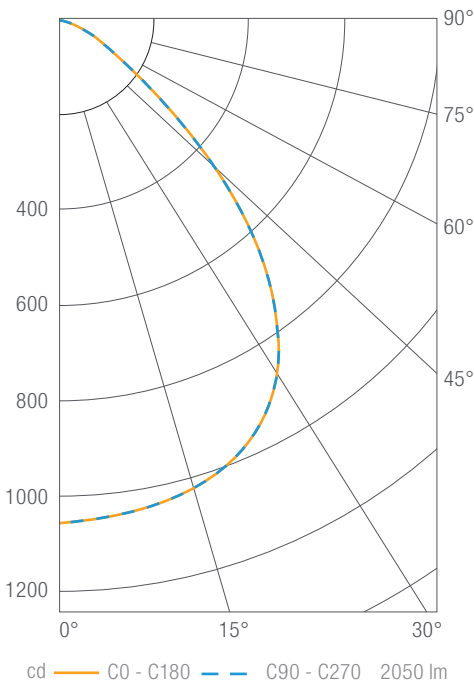

Luminous Intensity

Gamma	C 0°
0°	1058
5°	1053
10°	1042
15°	1024
20°	1000
25°	964
30°	904
35°	806
40°	670
45°	502
50°	338
55°	221
60°	145
65°	94
70°	52
75°	25
80°	12
85°	4
90°	0

Values in candela

Zonal Lumen Summary

Zone	Lumens	Luminaire %
0-30	832	41
0-40	1332	65
0-60	1921	94
0-90	2050	100
0-180	2050	100

Illuminance Chart

Distance from LED	Foot Candles	Diameter
2.5'	169	4.9'
5.0'	42	9.7'
7.5'	19	14.6'
9.0'	13	17.5'

Beam Angle: 88°

TRIAC/ELV DIMMER COMPATIBILITY

Recommended Phase-control Dimmers (Dims down to 5% nominal measured light output)

Brand	Series	Model Number	Max Load DCC2xxx07	Max Load DCC2xxx10
Control 4	Control 4	C4-APD120	10	9
Cooper	Decorator	DLC03P, DAL06P	25	20
Legrand	Adorne	ADTP703TU	35	30
Lutron	Caseta	PD-6WCL	12	10
	CL Series	AYCL-153, CTCL-153, DVCL-153, LGCL-513, SCL-153, TGCL-513	12	10
	CL Series	AYCL-253, DVCL-253	20	15
	Grafik Eye 3000	QSGR-3P	30	25
	Grafik Sys / Homeworks	RPM-4A	25	20
	Grafik Sys / Homeworks	RPM-4U	30	25
	Maestro CL	MACL-153M, MSCL-OP153M, MSCL-VP153M	12	10
	Maestro Wireless	MRF2-6ELV, MRF2-6CL	12	10
	Radio RA	RRD-6NA, RRD-6CL, RRD-6D	12	10

Compatible Phase-control Dimmers¹ (Dims down to 20% nominal measured light output)

Brand	Series	Model Number	Max Load DCC2xxx07	Max Load DCC2xxx10
Cooper	Slide	SLC03P, SAL06P	25	20
Legrand	Harmony	H703PTU, HCL453P	30	25
Leviton	IllumaTech Slide	IPE04	25	20
	SureSlide	6621, 6674	10	10
Lutron	Diva	DV-600	12	10
	Maestro	MA-600	12	9
	Maestro ELV	MAELV-600, MSCELV-600	35	30
	Maestro Wireless	MRF2-6ND	12	10
	Power Booster	PHPM-PA, PPHM-WBX	25	20
	Sunrise	SR400RPC120, ZP260QEW	20	15
Watt Stopper	Digital Light Management	LMRC-221	160	150
	Dimming Sensor	PW-100D	14	12

¹ Dimmer compatibility reflects performance compatibility only. Please reference your local codes for application.

**DIMMER COMPATIBILITY****Recommended 0-10V Dimmers** (Dims down to 1% nominal measured light output)

Brand	Series	Model Number	Max Load DCC2xxx07	Max Load DCC2xxx10	Max Load DCC2xxx15	Max Load DCC2xxx20
Legrand	Titan	CD4FB	80	65	97	71
Leviton	IllumaTech	IP710-DLZ	40	30	46	34
Lithonia	Synergy	ISD BC	35	30	46	34
Lutron	Diva	DTV	60	50	73	54
	Nova	NFTV	60	50	110	78
	Nova	NTSTV-DV	60	50	105	76
Watt Stopper	Micro Decorator Style	DCLV1	60	50	135	95