

M Series Cylinder

Project:	Type:
Product Code:	Date:

V102523



4" Wall Mount

- Integrated Drivers allow for down to 0.1% dimming options within the pendant
- Customize your cylinder with over one million configurations, allowing for easy maintenance and on-site modifications
- Wet location configurations available for exterior locations
- Die-cast aluminum trims with no visible hardware for a sleek, symmetrical design

CYLINDER

Mount

Wall Mount

Size

Diameter: 4"

Height: Medium (8"), Large (12")

Trims

Standard, Snoot, Decorative, Hyperbolic

Finish

White, Black, Brushed Aluminum, Bronze, Custom Color

EMERGENCY LIGHTING

Optional Remote Inverter or Emergency LED Driver for lighting up to 90 minutes in event of power failure

LIGHT OUTPUT & DISTRIBUTION

Lumens (Power)

750 lm (9.5W), 1000 lm (12.5W), 1250 lm (14.3W), 1500 lm (16.5W), 2000 lm (24.5W), 2500 lm (27.5W), 3000 lm (34W)

Color Quality

93 CRI, 2-step SDCM

Color Temperature

- 2700K ● 3000K ● 3500K
- 4000K ● Warm Dim (3000K–1800K)
- Tunable White (4000K–1800K)
- Tunable White (6500K–2700K)

Beam Spread

- ▲ Narrow Spot (15°) ▲ Spot (25°)
- ▲ Flood (40°) ▲ Wide Flood (60°)
- ▲ General (90°+)

Lighting Type

- Downlight
- Up and downlight
- Adjustable

POWER & CONTROLS

Input Voltage

120 / 277V

Dimming

0-10V (120/277V): 1%
TRIAC/ELV (120V): 1%
DALI-2 (120/277V): 0.1%

SPECIALTY LENS

- Hexcell Louver

RATINGS

- Wet Location / IP65 Rated Configurations Available
- NSF Listed (White and Black Finish Only)
- DarkSky Approved (Downlight only, CCT less than or equal to 3000K)

WARRANTY

5 year limited warranty; 50,000 hours



PRODUCT BUILDER

CYLINDER	<input type="text" value="DC4"/>	DC4 4" Cylinder			
MOUNT	<input type="text" value="WM"/>	WM Wall Mount			
MOISTURE RATING	<input type="text"/>	S Standard (Damp Location)	W Wet Location ¹		
LENGTH	<input type="text"/>	M Medium (8") 2000 lm Max	L Large (12") 3000 lm Max		
LIGHT OPTIONS	<input type="text"/>	D Fixed ¹	A Adjustable ²		
LUMENS DOWN ³	<input type="text"/>	07 750 lm ¹	10 1000 lm ¹	12 1250 lm ⁴	15 1500 lm ⁴
		20 2000 lm ^{4,5}	25 2500 lm ^{4,5}	30 3000 lm ^{4,5}	
BEAM SPREAD DOWN	<input type="text"/>	GA General Ambient (90°+) ^{4,6}	NS Narrow Spot (15°) ⁸	SP Spot (25°)	
		FL Flood (40°)	WF Wide Flood (60°) ⁴		
SPECIALTY LENS DOWN	<input type="text"/>	0 None ¹	H Hexcell Louver ⁷		
LUMENS UP ^{3,9}	<input type="text"/>	00 None	07 750 lm ¹	10 1000 lm ¹	
		12 1250 lm ¹	15 1500 lm ¹	20 2000 lm ⁵	
BEAM SPREAD UP ⁹	<input type="text"/>	00 None	GA General Ambient (90°+) ⁶	NS Narrow Spot (15°) ⁸	
		SP Spot (25°)	FL Flood (40°)	WF Wide Flood (60°)	
CCT	<input type="text"/>	27 2700K	30 3000K	35 3500K	40 4000K
		3W Warm Dim (3000K-1800K) ¹⁰	T1 Tunable White (4000K-1800K) ¹¹	T2 Tunable White (6500K-2700K) ¹¹	
FINISH	<input type="text"/>	WH White	BK Black	BA Brushed Aluminum	
		BZ Bronze	CC Custom Color		
DIMMING	<input type="text"/>	T TRIAC/ELV (1%)	O 0-10V (1%)	D DALI-2 (0.1%) ¹²	
EMERGENCY	<input type="text"/>	00 None	EM EM, Remote Test Switch ¹³		
TRIM DOWN	<input type="text"/>	R Round Standard Trim ¹	H Hyperbolic Trim	S Snoot (black only)	
		D Decorative Trim ^{6,14}	L Low Profile Decorative Trim ^{6,14}		
TRIM UP	<input type="text"/>	[Blank] N/A	R Round Standard Trim ¹	H Hyperbolic Trim	
		S Snoot (black only)	D Decorative Trim ^{6,14}	L Low Profile Decorative Trim ^{6,14}	

¹ Required for Wet Location/IP65 rating

¹ Only available in 750, 1000, 1250, 1500 or 2000 lm; with Round Standard, Decorative, or Low Profile Trim

² Only available in 750 or 1000 lm; Damp Location moisture rating; Round Standard or Hyperbolic trim

³ Sum of Lumens cannot be greater than 2000 lm for Medium size and 3000 lm for Large size

⁴ Not available in Adjustable

⁵ Only available in 0-10V

⁶ Only available in 750 lm, 1000 lm, 1250 lm, or 1500 lm

⁷ Only available for Adjustable; Not available with DALI-2

⁸ Not available in Warm Dim or Tunable White

⁹ Only applicable to Large size; Otherwise, select None; Uplight cannot be Adjustable

¹⁰ Only available in 1000 lm; Not available in Narrow Spot

¹¹ Only available in 1000 lm downlight or 750 lm adjustable, DALI-2 dimming only; Not available in Narrow Spot

¹² Only available in 1000 lm Warm Dim, Tunable White or 1250 lm Static CCT Downlight and 1000 lm Warm Dim or Static CCT and 750 lm Tunable White Adjustable

¹³ Not available in Uplight; TRIAC/ELV driver utilizes micro inverter; 0-10V drivers utilize EM Kit mounted above ceiling with emergency LED driver & remote test switch

¹⁴ Only available in General Ambient beam spread



PRODUCT BUILDER

ACCESSORIES

DCCX-RW	Round Standard Trim, White
DCCX-RB	Round Standard Trim, Black
DCCX-RA	Round Standard Trim, Brushed Aluminum
DCCX-RZ	Round Standard Trim, Bronze
DCCX-RC	Round Standard Trim, Custom Color
DCCX-HW	Hyperbolic Trim, White
DCCX-HB	Hyperbolic Trim, Black
DCCX-HA	Hyperbolic Trim, Brushed Aluminum
DCCX-HZ	Hyperbolic Trim, Bronze
DCCX-HC	Hyperbolic Trim, Custom Color
DCCX-S	Snoot

PRODUCT SUMMARY



LED: Cree® LED, Bridgelux

DELIVERED LUMENS: 750 lm (9.5W), 1000 lm (12.5W), 1250 lm (14.3W), 1500 lm (16.5W), 2000 lm (24.5W), 2500 lm (27.5W), 3000 lm (34W)

EFFICACY: 79 lm/W, 80 lm/W, 87lm/W, 91 lm/W, 82 lm/W, 91 lm/W, 88 lm/W

COLOR QUALITY: 93+ CRI, 2-step SDCM

CCT: 2700K, 3000K, 3500K, 4000K, Warm Dim (3000K-1800K), Tunable White (4000K-1800K), Tunable White (6500K-2700K)

DIMMING: Down to 1% for TRIAC/ELV at 120V, 1% for 0-10V at 120/277V, 0.1% DALI-2

INPUT VOLTAGE: 120/277V, 50/60Hz

MAX INPUT CURRENT (120V): 0.085 amps (750 lm), 0.110 amps (1000 lm), 0.125 amps (1250 lm), 0.145 amps (1500 lm), 0.205 amps (2000 lm), 0.235 amps (2500 lm), 0.290 amps (3000 lm)

MAX INPUT CURRENT (277V): 0.045 amps (750 lm), 0.055 amps (1000 lm), 0.060 amps (1250 lm), 0.070 amps (1500 lm), 0.100 amps (2000 lm), 0.110 amps (2500 lm), 0.135 amps (3000 lm)

POWER FACTOR: Greater than 0.9

TOTAL HARMONIC DISTORTION: Less than 20%

AMBIENT OPERATING TEMPERATURE: -20°C to 40°C

EMERGENCY LIGHTING: Optional installer mounted Remote Inverter or Emergency LED Driver for lighting up to 90 minutes in event of power failure

PHOTOMETRIC TESTING: Tested in accordance to IESNA LM-79-2008

LISTINGS: ENERGY STAR® qualified*, California Title 24 2019 - 2022 JA8-E Compliant, UL Listed for Wet Location (option), IP65 rated (option), UL Certified US-CA, Declare, NSF/ANSI-2 Splash Zone Safe**, Dark Sky Compliant (option), DALI-2 Compliant

LIFETIME: 50,000 hours at 70% lumen maintenance

CYLINDER: Extruded aluminum; 4" (small), 8" (medium), 12" (large)

FINISH: White, Black, Bronze, Brushed Aluminum, Custom Color

MOUNT: Wall Mount: Installs in most one-gang switch boxes. Wet Location Wall Mount: Installs in most two-gang switch, 3" octagonal, 4" octagonal, 3" round, 4" round and 4" square boxes.

WARRANTY: 5 year limited warranty

* Refer to ENERGY STAR Certified light fixtures database

** This product is evaluated in accordance to NSF/ANSI 2 for Splash Zones having designated trim finishes

Wall Mount

DC4WM

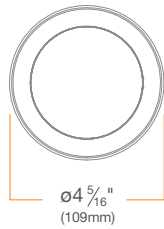
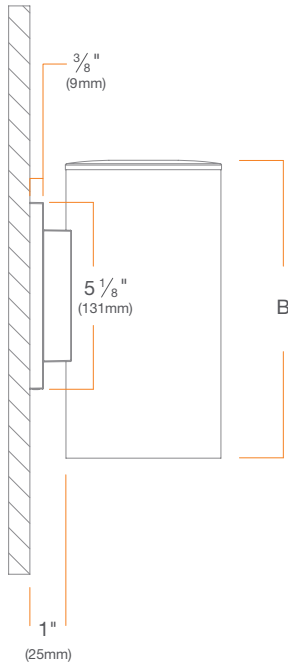

Wall Mount, Wet Location

DC4WMW

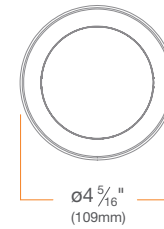
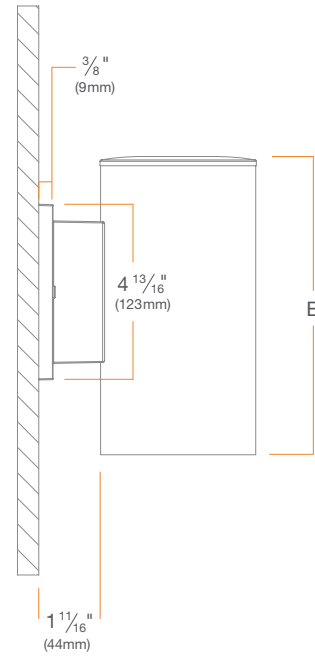

CYLINDER SIZE	B
Medium	8 1/4" [210 mm]
Large	12 1/4" [311 mm]

Wall Mount, Uplight & Downlight

DC4WM

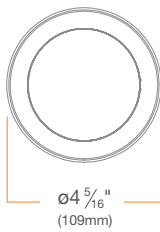
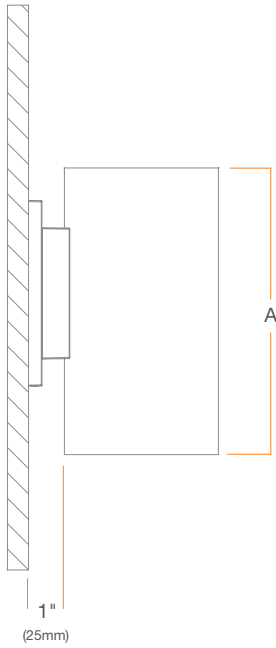

CYLINDER SIZE	A
Large	12" [305 mm]

Decorative Trim

DCCX-D

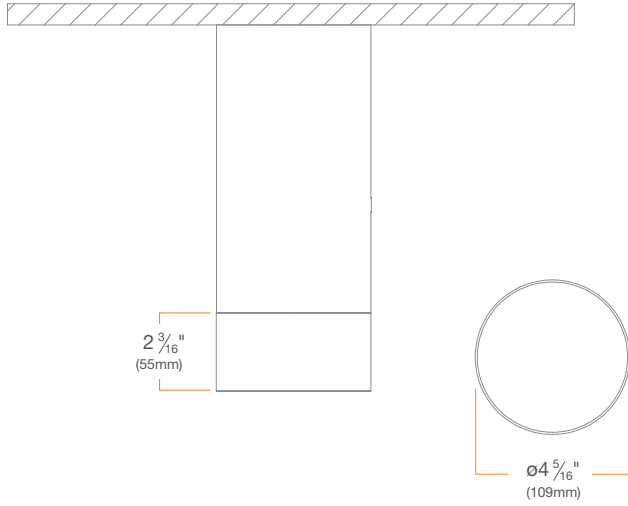

Low-Profile Decorative Trim

DCCX-L

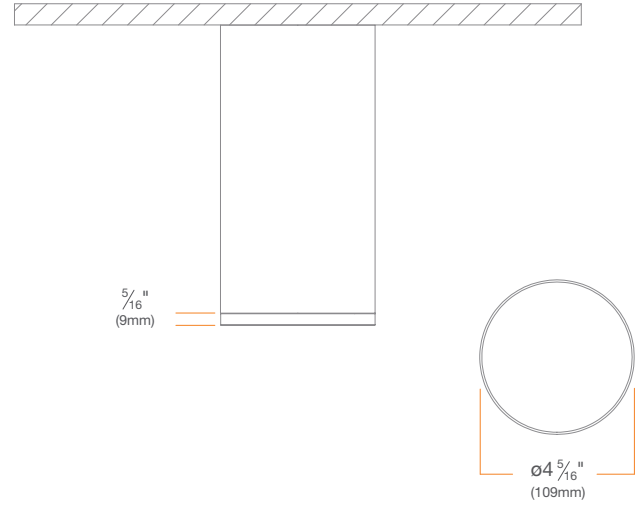

Snoot Trim

DCCX-S

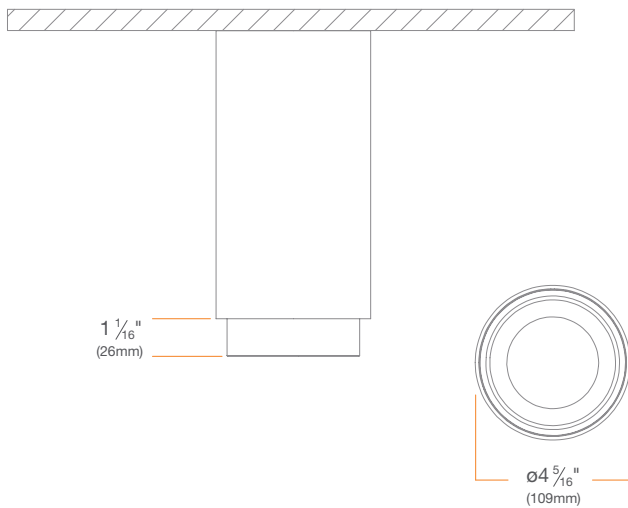

Emergency Lighting Kit

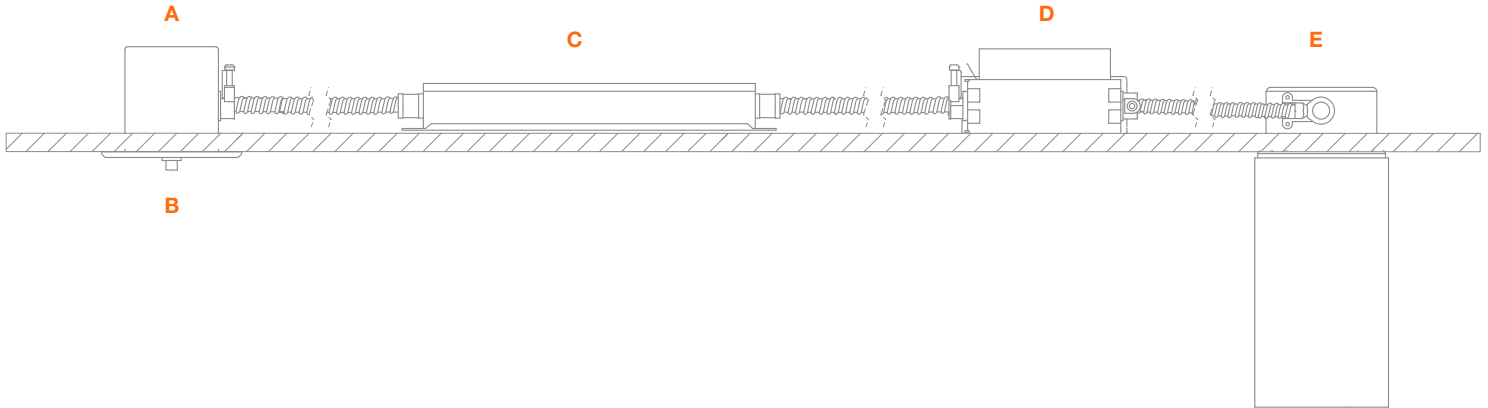

ITEM	LENGTH	WIDTH	HEIGHT
A Junction Box (not included)	N/A	N/A	N/A
B Remote Test Switch	4 1/2" [114 mm]	2 3/4" [70 mm]	9/16" [15 mm]
C Emergency LED Driver (Battery)	10 5/8" [271 mm]	2 5/16" [58 mm]	1 1/2" [38 mm]
D Cylinder Driver	4 15/16" [126 mm]	3 3/8" [85 mm]	2 1/16" [68 mm]
E Junction Box (not included)	N/A	N/A	N/A

PRODUCT SUMMARY

M Series Cylinder Fixed, 1000 lm, 3000K, Narrow Spot

DC4xxxxD10NSxxxxx30

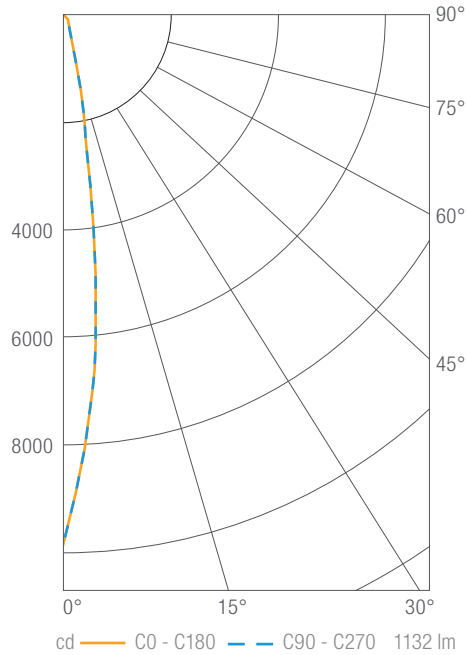

Luminous Intensity

Gamma	C 0°
0°	9823
5°	6600
10°	2335
15°	734
20°	357
25°	244
30°	195
35°	159
40°	116
45°	85
50°	61
55°	42
60°	28
65°	16
70°	7
75°	4
80°	2
85°	1
90°	0

Values in candela

Zonal Lumen Summary

Zone	Lumens	Luminaire %
0-30	906	80
0-40	1004	89
0-60	1110	98
0-90	1131	100
0-180	1132	100

Illuminance Chart

Distance from LED	Foot Candles	Diameter
3'	1091	0.7'
6'	273	1.5'
9'	121	2.2'
12'	68	2.9'

Beam Angle: 14°

M Series Cylinder Fixed, 1000 lm, 3000K, Spot

DC4xxxxD10SPxxxxx30

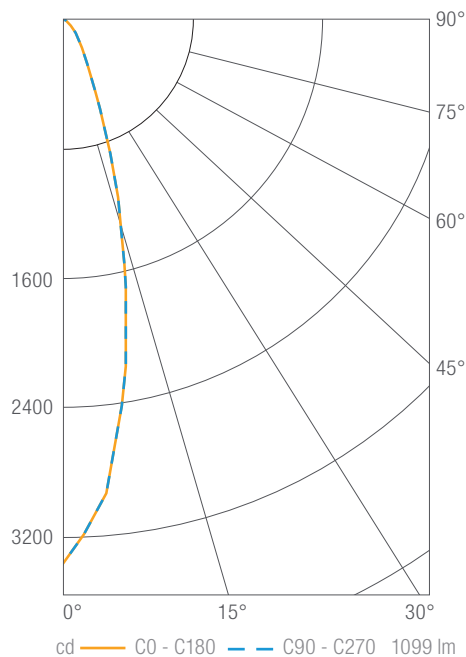

Luminous Intensity

Gamma	C 0°
0°	3366
5°	2967
10°	2203
15°	1391
20°	775
25°	419
30°	248
35°	167
40°	119
45°	87
50°	62
55°	43
60°	26
65°	15
70°	7
75°	4
80°	2
85°	1
90°	0

Values in candela

Zonal Lumen Summary

Zone	Lumens	Luminaire %
0-30	862	78
0-40	971	88
0-60	1078	98
0-90	1098	100
0-180	1099	100

Illuminance Chart

Distance from LED	Foot Candles	Diameter
3'	374	1.4'
6'	93	2.8'
9'	42	4.2'
12'	23	5.6'

Beam Angle: 26°

PRODUCT SUMMARY

M Series Cylinder Fixed, 1000 lm, 3000K, Flood

DC4xxxxD10FLxxxxx30

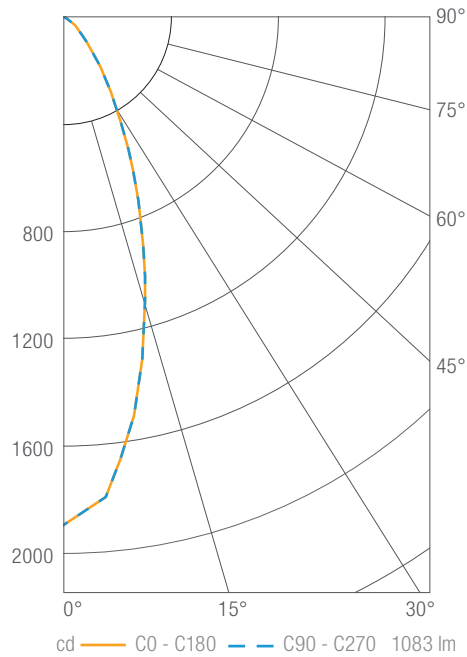

Luminous Intensity

Gamma	C 0°
0°	1890
5°	1792
10°	1503
15°	1161
20°	849
25°	589
30°	391
35°	256
40°	162
45°	107
50°	74
55°	51
60°	30
65°	18
70°	8
75°	5
80°	3
85°	1
90°	0

Values in candela

Zonal Lumen Summary

Zone	Lumens	Luminaire %
0-30	760	70
0-40	925	85
0-60	1058	98
0-90	1081	100
0-180	1083	100

Illuminance Chart

Distance from LED	Foot Candles	Diameter
3'	210	2.0'
6'	52	4.0'
9'	23	6.0'
12'	13	8.0'

Beam Angle: 37°

M Series Cylinder Fixed, 1000 lm, 3000K, Wide Flood

DC4xxxxD10WFxxxxx30

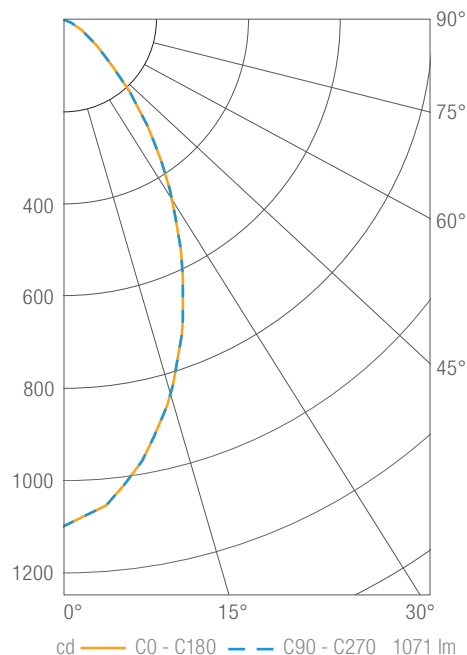

Luminous Intensity

Gamma	C 0°
0°	1100
5°	1058
10°	973
15°	866
20°	743
25°	609
30°	478
35°	361
40°	252
45°	161
50°	102
55°	68
60°	41
65°	24
70°	11
75°	6
80°	4
85°	2
90°	0

Values in candela

Zonal Lumen Summary

Zone	Lumens	Luminaire %
0-30	620	58
0-40	845	79
0-60	1037	97
0-90	1069	100
0-180	1071	100

Illuminance Chart

Distance from LED	Foot Candles	Diameter
3'	122	3.1'
6'	31	6.2'
9'	14	9.3'
12'	8	12.3'

Beam Angle: 55°

PHOTOMETRY

M Series Cylinder Fixed, 1000 lm, 3000K, General Ambient

DC4xxxxD10GAxxxxx30

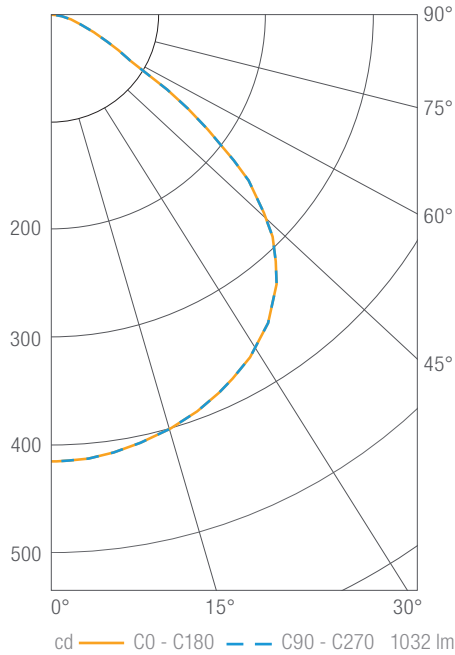

Luminous Intensity

Gamma	C 0°
0°	416
5°	415
10°	410
15°	403
20°	394
25°	382
30°	369
35°	351
40°	327
45°	291
50°	240
55°	162
60°	84
65°	54
70°	33
75°	21
80°	12
85°	6
90°	1

Values in candela

Zonal Lumen Summary

Zone	Lumens	Luminaire %
0-30	333	32
0-40	557	54
0-60	942	91
0-90	1024	99
0-180	1032	100

Illuminance Chart

Distance from LED	Foot Candles	Diameter
3'	46	7.8'
6'	12	15.5'
9'	5	23.3'
12'	3	31.1'

Beam Angle: 100°

M Series Cylinder Adjustable, 750 lm, 3000K, Narrow Spot

DC4xxxxA07NSxxxxx30

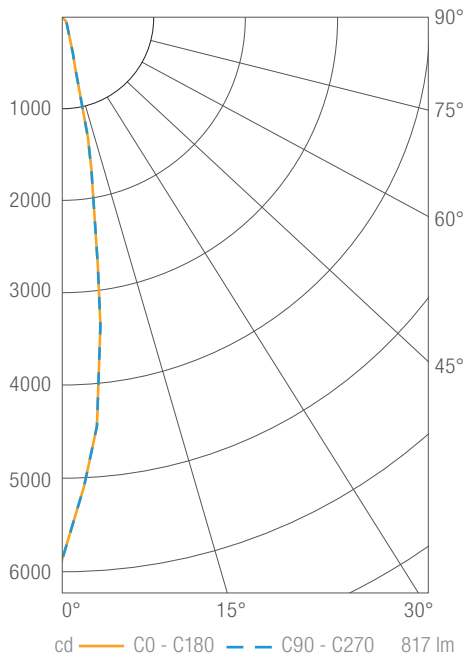

Luminous Intensity

Gamma	C 0°
0°	5897
5°	4418
10°	1911
15°	561
20°	280
25°	165
30°	117
35°	87
40°	69
45°	57
50°	47
55°	38
60°	31
65°	23
70°	16
75°	10
80°	4
85°	1
90°	0

Values in candela

Zonal Lumen Summary

Zone	Lumens	Luminaire %
0-30	645	79
0-40	701	86
0-60	781	96
0-90	817	100
0-180	817	100

Illuminance Chart

Distance from LED	Foot Candles	Diameter
3'	655	0.8'
6'	164	1.7'
9'	73	2.5'
12'	41	3.3'

Beam Angle: 16°

PHOTOMETRY

M Series Cylinder Adjustable, 750 lm, 3000K, Spot

DC4xxxxA07SPxxxxx30

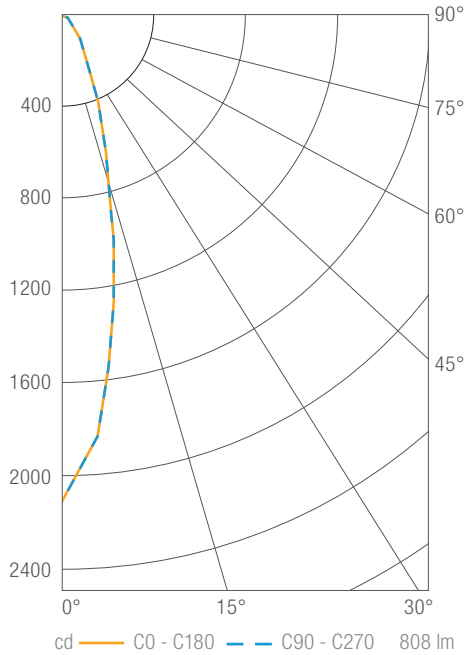

Luminous Intensity

Gamma	C 0°
0°	2105
5°	1826
10°	1282
15°	800
20°	497
25°	310
30°	201
35°	137
40°	98
45°	73
50°	57
55°	45
60°	35
65°	23
70°	12
75°	5
80°	3
85°	2
90°	0

Values in candela

Zonal Lumen Summary

Zone	Lumens	Luminaire %
0-30	573	71
0-40	668	83
0-60	773	96
0-90	808	100
0-180	808	100

Illuminance Chart

Distance from LED	Foot Candles	Diameter
3'	234	1.3'
6'	58	2.6'
9'	26	3.9'
12'	15	5.2'

Beam Angle: 28°

M Series Cylinder Adjustable, 750 lm, 3000K, Flood

DC4xxxxA07FLxxxxx30

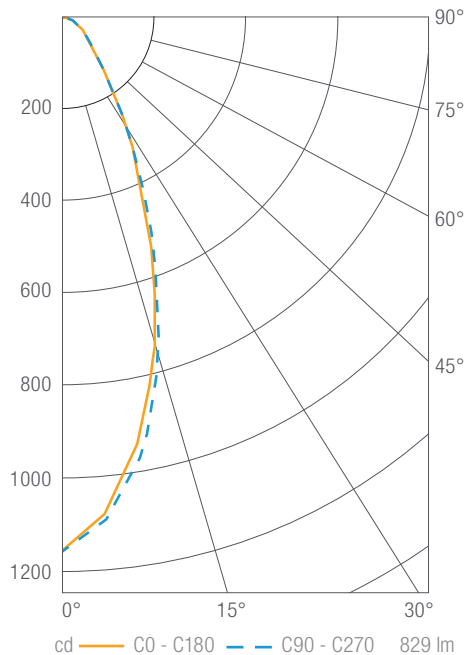

Luminous Intensity

Gamma	C 0°
0°	1158
5°	1081
10°	941
15°	765
20°	576
25°	414
30°	288
35°	192
40°	130
45°	96
50°	76
55°	61
60°	49
65°	38
70°	28
75°	18
80°	10
85°	4
90°	0

Values in candela

Zonal Lumen Summary

Zone	Lumens	Luminaire %
0-30	510	62
0-40	633	76
0-60	766	92
0-90	829	100
0-180	829	100

Illuminance Chart

Distance from LED	Foot Candles	Diameter
3'	129	2.2'
6'	32	4.5'
9'	14	6.7'
12'	8	9.0'

Beam Angle: 41°