

Project:	Type:
Product Code:	Date:

V 032525



## Artafex 4" Square Adjustable

**HIGH PERFORMANCE** Produces up to 750 lumens of True Spectrum® lighting for natural, true-to-life colors without sacrificing stellar efficiency

**PRECISE CONTROL** Field-changeable light distribution ranging from 15° to 90°+

**DIM TO DARK** Smooth, flicker-free dimming down to 0.1% with centralized or local control

**FAST INSTALL** Integrated driver, plug-and-play connection, and Twist & Lock Trims

**MODULAR DESIGN** Flexibility during and after installation with interchangeable modules, optics and trims

### INSTALLATION

#### Ceiling Thickness

New Construction: 1/2" up to 1 3/4"  
 Spray Foam: 1/2" up to 2"  
 Remodel: 5/8" up to 1 1/4"  
 Low Profile: 1/2" up to 1 1/4"

#### Ceiling Material

Drywall, Millwork, Concrete

### TRIMS

#### Style

Standard, Flangeless, Pinhole

#### Finish

White, Black, Custom Color (RAL Colors)

### LIGHT OUTPUT & DISTRIBUTION

#### Module

Adjustable

#### Adjustment

360° direction aim, 45° tilt

#### Lumens (Power)

750 lm (12.5W)



#### Color Quality

True Spectrum® 93 CRI, 3-step SDCM

#### Color Temperature

 Tunable White (4000K-1800K)

#### Beam Spread

 25° Spot       40° Flood  
 60° x 30° Linear Spread

### POWER & CONTROLS





#### Input Voltage

120 / 277V

#### Dimming

PhaseX (0.1%)

### RATINGS & CERTIFICATIONS

-  IC (Insulation Contact) Rated
-  ASTM E283 Certified Air Tight
-  Chicago Plenum
-  UL Listed for Damp Location
-  RoHS Compliant
-  Code compliant for use in fire-rated assemblies up to a maximum of 2-hours

### WARRANTY

5 year limited warranty; 50,000 hours



Declare.



## PRODUCT BUILDER

### HOUSING

PRODUCT CODE		APPLICATION		SHAPE		RATING	
M4				S			
M4	4" Housing	NC	New Construction	S	Square	S	Standard
		CP	Chicago Plenum <sup>1</sup>			F	Fire Rated
		LT	Low Profile, TRIAC/ELV (3" Plenum)				
		RM	Remodel				
		SF	Spray Foam <sup>1</sup>				

<sup>1</sup> Only available in Standard rating

### GATEWAY

PRODUCT CODE	
ART-GWX	
ART-GWX	DMX Input

### 4" MODULE

PRODUCT CODE		LUMENS		COLORMETRIC		CCT		BEAM SPREAD		FINISH		DIMMING	
ART4A		07		T		T1						X	
ART4A	Adjustable	07	750 lm	T	True Spectrum®	T1	Tunable White (4000K- 1800K)	SP	Spot (25°)	[Blank]	Black	X	PhaseX
								FL	Flood (40°)	W	White		
								LS	Linear Spread (60° x30°)				

### TRIM

PRODUCT CODE		FINISH		OPTION	
M4TSQ	Round on Square	WH	White	[Blank]	None
M4TSP	Pinhole <sup>2</sup>	BK	Black	FL	Flangeless <sup>3</sup>
		BZ	Bronze		
		CW	Clear Diffuse, White Flange		
		CC	Custom Color (RAL Colors)		

<sup>2</sup> Not available in Bronze or Clear Diffuse finish

<sup>3</sup> Mud plate is required for all Flangeless trims except for wood ceiling applications.

Not available in spray foam or remodel application; Not available in Clear Diffuse finish

### ACCESSORIES

M4XSMUD	Flangeless Mud Plate (Required for flangeless drywall application)
M4KSTEMPLATE	Wood Template (Recommended for flangeless trim wood installation)



## PRODUCT BUILDER

---

### OPTICS ACCESSORIES

PRODUCT CODE	
<b>DID4X-SP</b>	Adjustable Spot (25°)
<b>DID4X-FL</b>	Adjustable Flood (40°)
<b>DID4X-LS</b>	Adjustable Linear Spread (60° x 30°)
<b>DID4X-OP</b>	Adjustable Optics Kit: Spot (25°), Flood (40°), Linear Spread (60° x 30°), Soft Focus

## MODULE

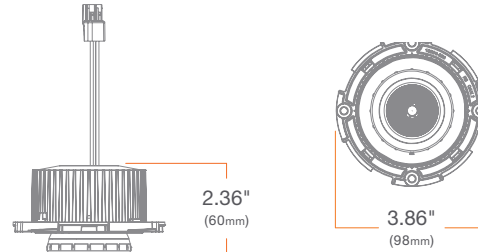

## SUMMARY

	TUNABLE WHITE
<b>CCT</b>	4000K - 1800K
<b>LUMENS (POWER)</b>	750 lm (12.5W)
<b>EFFICACY</b>	60 lm/W
<b>COLOR QUALITY</b>	True Spectrum® 93 CRI, 3-step SDCM
<b>BEAM SPREAD</b>	Spot (25°), Flood (40°), Linear Spread (60° x 30°)
<b>DIMMING</b>	PhaseX
<b>LED CHIP</b>	Bridgelux
<b>LISTINGS</b>	ENERGY STAR® qualified <sup>1</sup> , California Title 24 2016-2022 JA8-E compliant, UL Listed for Damp Location <sup>2</sup> , UL Certified US-CA, Declare, RoHS compliant, DALI-2 Compliant
<b>ADJUSTMENT</b>	360° directional aim, 45° tilt
<b>SLOPE CEILING COMPATIBILITY</b>	Up to 45°

<sup>1</sup> Refer to ENERGY STAR Certified light fixtures database

<sup>2</sup> Under covered areas only

## ADDITIONAL

**INPUT VOLTAGE:** 120/277V, 50/60Hz

**MAX INPUT CURRENT (120V):** 0.13 amps

**MAX INPUT CURRENT (277V):** 0.065 amps

**CONNECTOR:** PowerPlug® Luminaire Disconnect Model 182, 6-pin Molex

**POWER FACTOR:** Greater than 0.9

**TOTAL HARMONIC DISTORTION:** Less than 20%

**AMBIENT OPERATING TEMPERATURE:** -20°C to 40°C

**WARRANTY:** 5 year limited warranty; 50,000 hours at 70% lumen maintenance

## HOUSING



## New Construction

### SUMMARY

**JUNCTION BOX:** Equipped with 12 knockouts: four 1/2" trade size knockouts on side, two 3/4" and two 1/2" trade size knockouts on top and four romex knockouts on top. Approved for 8 (four in, four out) #12 AWG 70°C.

**MOUNTING:** Pre-installed mounting brackets allow vertical adjustment of bar hangers up to 1 1/4"

**CEILING:** Standard Version (Deep): 1/2" to 1 3/4"  
Low Profile Version: 1/2" to 1 1/4"

**CUTOUT:** 4" (102mm) square opening

**LISTINGS:** Metallic outlet box certified UL514A, code compliant for use in appropriate fire-rated assemblies for up to 2-hours (Fire Rated only), STC/IIC Sound Rated, ASTM E283 certified Air Tight, IC (Insulation Contact) rated

**WARRANTY:** 5 year limited warranty

### ALTERNATE DIMMING SPECIFICATIONS

**INPUT VOLTAGE:** 120/277V, 50/60Hz

**MAX INPUT CURRENT (120V):** 0.090 amps, 0.107 amps

**MAX INPUT CURRENT (277V):** 0.042 amps, 0.050 amps

**POWER FACTOR:** Greater than 0.9

**TOTAL HARMONIC DISTORTION:** Less than 20%

New Construction

- M4NCSS (Standard)
- M4NCSE (Fire Rated)
- M4CPSS (Chicago Plenum)

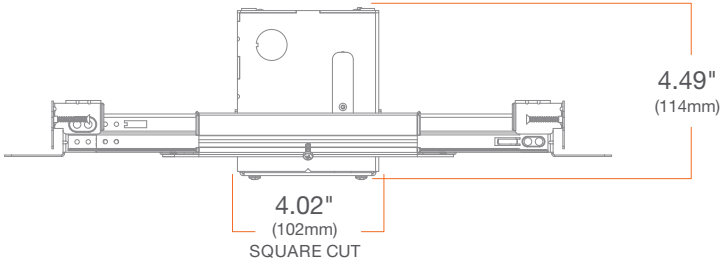

Low-Profile

- M4LTSS (Standard)
- M4LTSE (Fire Rated)

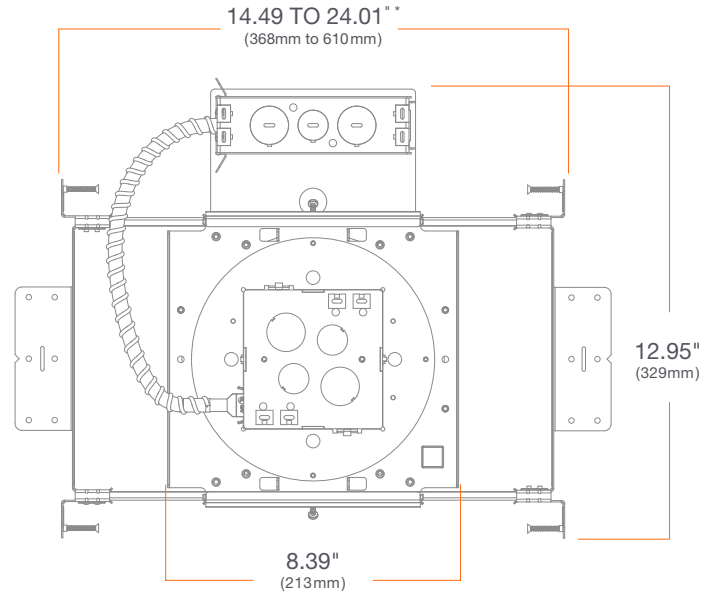
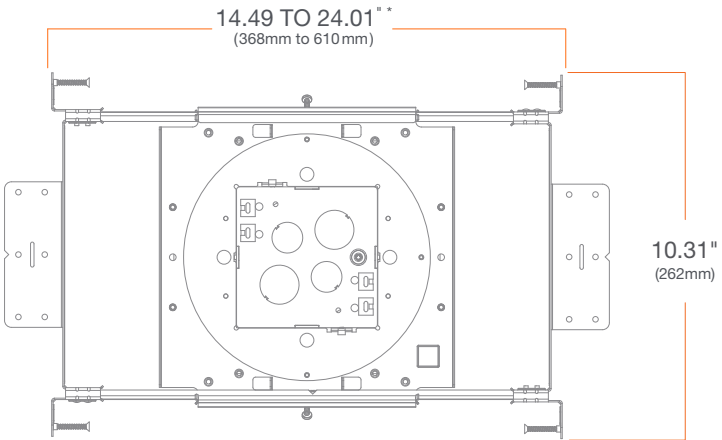
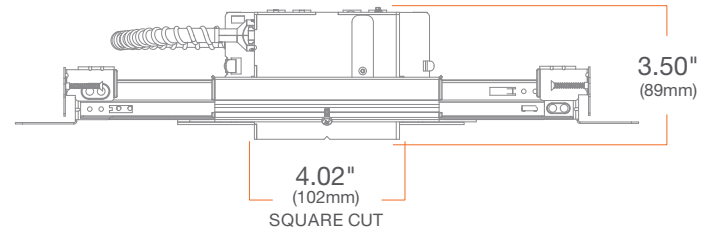

\* Can be field cut to minimum 10" (254mm)

## HOUSING

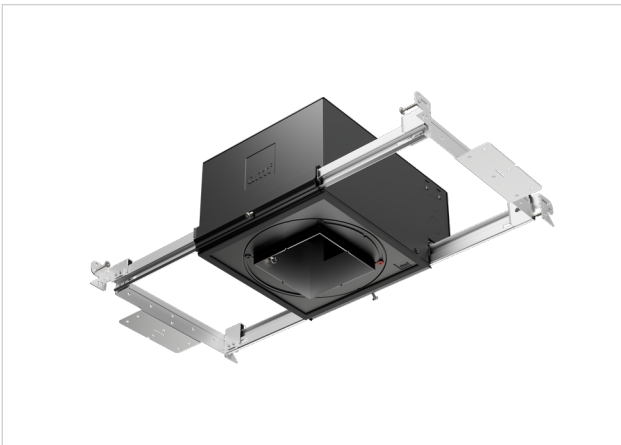

# Spray Foam

**M4SFRS**

### SUMMARY

**JUNCTION BOX:** Equipped with six knockouts: four 1/2" trade size knockouts, two 3/4" trade size knockouts, and four romex knockouts. Approved for 8 (four in, four out) #12 AWG 70° C

**MOUNTING:** Adjustable Bar Hanger for 16" to 24" joist spacing. Compatible with traditional joists, Armstrong™ ceiling, Hat Channel and T-bar

**CEILING:** 1/2" up to 2"

**CUTOUT:** 4" (102mm) square opening

**LISTINGS:** ASTM E283 certified Air Tight, IC (Insulation Contact) up to R-32 for Roll, Batt, and Loose Fill, up to R-60 Spray Foam with standard beveled trims, up to R-32 Spray Foam with other trims

**WARRANTY:** 5 year limited warranty

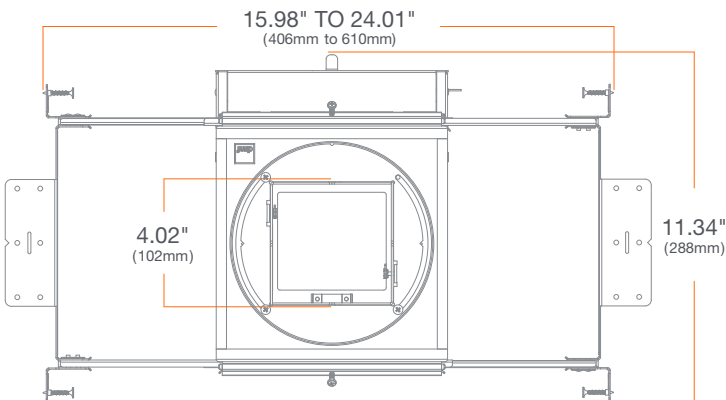
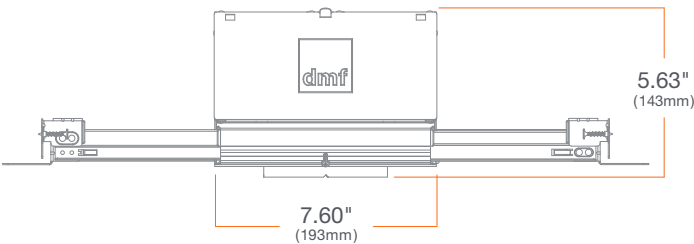

HOUSING

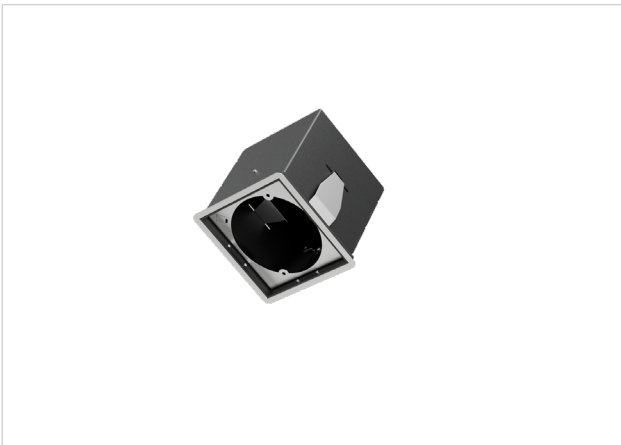

# Remodel

**M4RMSS (Standard)**  
**M4RMSF (Fire Rated)**

SUMMARY

**JUNCTION BOX:** Equipped with 8 knockouts: four 1/2" trade size knockouts on side, two 3/4" and two 1/2" trade size knockouts on top and four romex knockouts on top. Approved for 8 (four in, four out) #12 AWG 70°C.

**MOUNTING:** Pre-installed mounting spring clips

**CEILING:** 5/8" up to 1 1/4"

**CUTOUT:** 4" (102mm) square opening

**LISTINGS:** Metallic outlet box certified UL514A, code compliant for use in appropriate fire-rated assemblies for up to 2-hours (Fire Rated only), STC/IIC Sound Rated, ASTM E283 certified Air Tight, IC (Insulation Contact) rated

**WARRANTY:** 5 year limited warranty

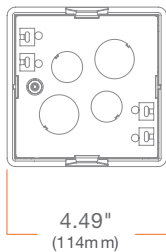
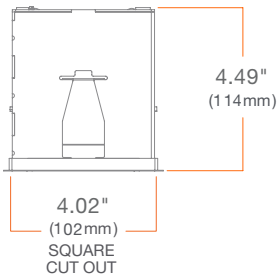



TRIMS



# 4" Square Trims

M4TS

SUMMARY

**CONSTRUCTION:** Die-cast aluminum

**INSTALLATION:** Twist & Lock

## Round on Square

M4TSQWH

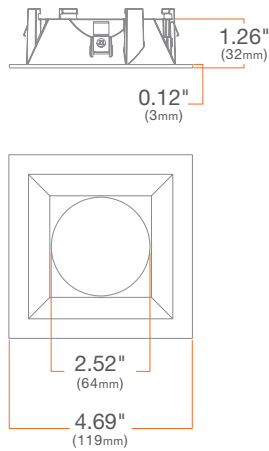

## Round On Square Flangeless

M4TSQWHFL

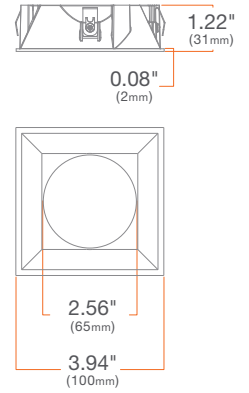

## Pinhole

M4TSPWH

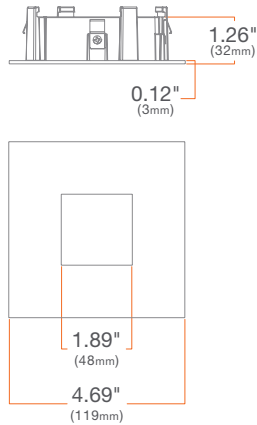

## Pinhole Flangeless

M4TSPWHFL

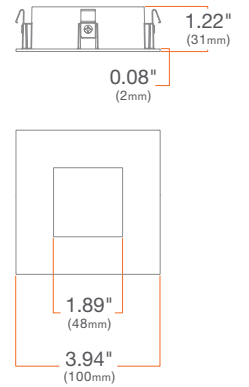

## ACCESSORIES

### Flangeless Mud Plate

#### M4XSMUD

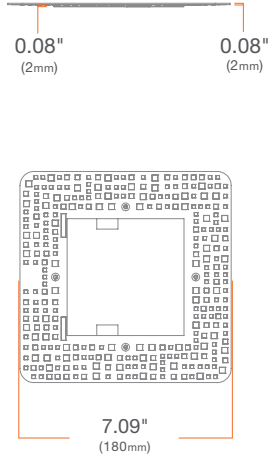

### Wood Template

#### M4KSTEMPLAT

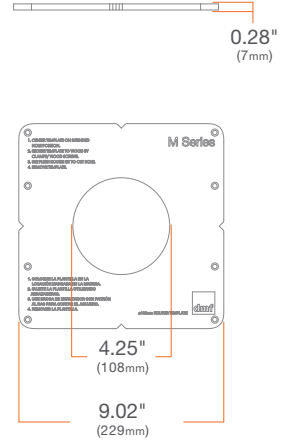

PHOTOMETRY

**ART4A** 750 lm, 3000K, Spot

ART4AM07930SP

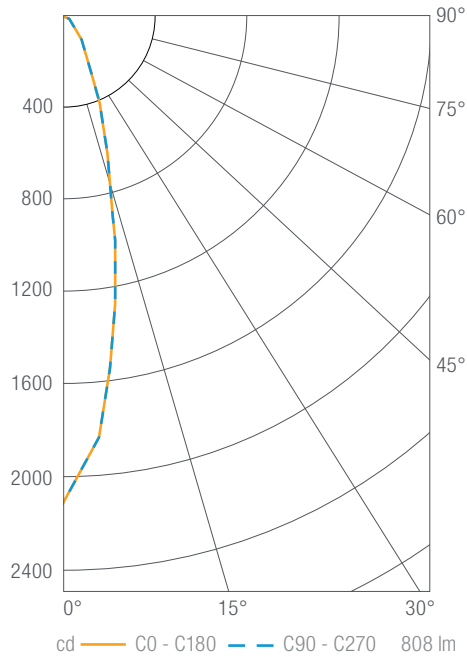

Luminous Intensity

Gamma	C 0°
0°	2105
5°	1826
10°	1282
15°	800
20°	497
25°	310
30°	201
35°	137
40°	98
45°	73
50°	57
55°	45
60°	35
65°	23
70°	12
75°	5
80°	3
85°	2
90°	0

Values in candela

Zonal Lumen Summary

Zone	Lumens	Luminaire %
0-30	573	71
0-40	668	83
0-60	773	96
0-90	808	100
0-180	808	100

Illuminance Chart

Distance from LED	Foot Candles	Diameter
3'	234	1.3'
6'	58	2.6'
9'	26	3.9'
12'	15	5.2'

Beam Angle: 28°

**ART4A** 750 lm, 3000K, Flood

ART4AM07930FL

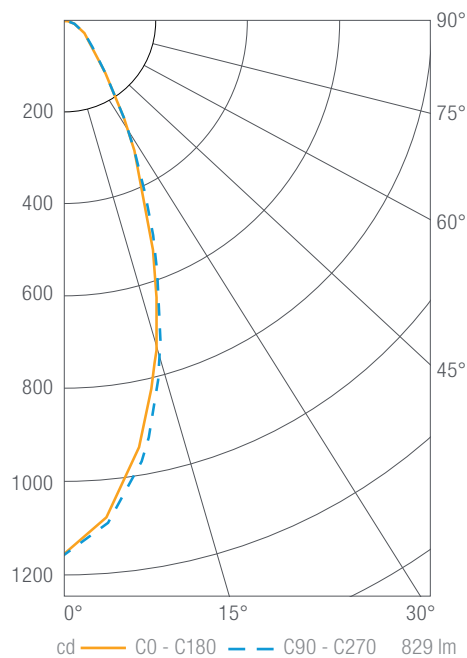

Luminous Intensity

Gamma	C 0°
0°	1158
5°	1081
10°	941
15°	765
20°	576
25°	414
30°	288
35°	192
40°	130
45°	96
50°	76
55°	61
60°	49
65°	38
70°	28
75°	18
80°	10
85°	4
90°	0

Values in candela

Zonal Lumen Summary

Zone	Lumens	Luminaire %
0-30	510	62
0-40	633	76
0-60	766	92
0-90	829	100
0-180	829	100

Illuminance Chart

Distance from LED	Foot Candles	Diameter
3'	129	2.2'
6'	32	4.5'
9'	14	6.7'
12'	8	9.0'

Beam Angle: 41°

PHOTOMETRY

**ART4A** 750 lm, 3000K, Linear Spread

ART4AM07930LS

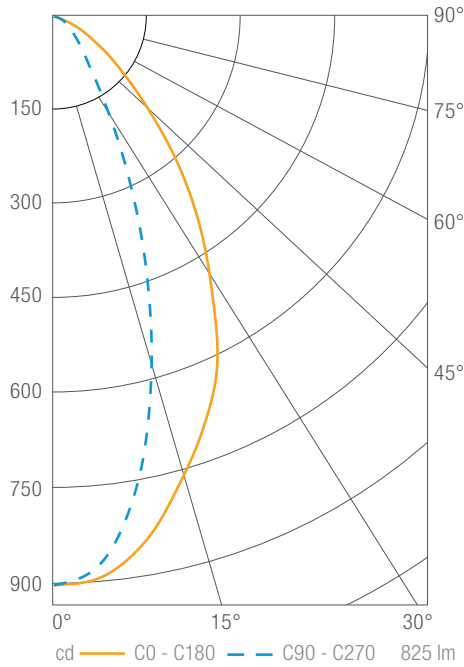

Luminous Intensity

Gamma	C 0°
0°	895
5°	885
10°	838
15°	763
20°	689
25°	608
30°	497
35°	399
40°	305
45°	216
50°	150
55°	103
60°	66
65°	41
70°	17
75°	4
80°	1
85°	1
90°	0

Zonal Lumen Summary

Zone	Lumens	Luminaire %
0-30	468	57
0-40	626	76
0-60	790	96
0-90	825	100
0-180	825	100

Illuminance Chart

Distance from LED	Foot Candles	Diameter
3'	99.5	3.8'
6'	24.9	7.7'
9'	11.1	11.5'
12'	6.2	15.3'

Beam Angle: 38°